



62ND ANNUAL

ROCKY MOUNTAIN CONFERENCE

ON MAGNETIC RESONANCE



FINAL PROGRAM AND ABSTRACTS

Endorsed by:

Colorado Section – American Chemical Society

&

Society for Applied Spectroscopy

July 23–27, 2023

Sonesta Denver Downtown

Denver, Colorado

www.rockychem.com

62ND ROCKY MOUNTAIN CONFERENCE ON MAGNETIC RESONANCE

July 22–27, 2023
Sonesta Denver Downtown
Denver, Colorado

Endorsed by:
**Colorado Section – American Chemical Society
&
Society for Applied Spectroscopy**

TABLE OF CONTENTS

Organizers and Chairpersons	2
Conference Supporters & Exhibitors	2
RMC Information	3
Registration	
Exhibition Schedule	
Conference Reception	
Conference Banquet & Awards Ceremony	
Messages	
Social Media	
Conference-at-a-Glance	3
Meeting Spaces	4
Exhibitors.....	4
PROGRAM SCHEDULE – 42 ND INTERNATIONAL EPR SYMPOSIUM.....	5
Sunday Pre-Conference Activities	6
Monday Oral Sessions	6-7
Tuesday Oral Sessions	7-8
Wednesday Oral Sessions	8-9
Thursday Oral Sessions	9
EPR Poster Sessions	11-12
RMCMR ABSTRACTS	13-52
INDEX OF PRESENTERS	53

www.rockychem.com

MILESTONE PRESENTATIONS, LLC

4255 South Buckley Road, #118, Aurora, CO 80013

Ph: 800-996-3233 or 303-690-3233 • **Fax:** 888-996-3296 or 303-690-3278

E-mail: info@rockychem.com

ORGANIZERS AND CHAIRPERSONS

ENDORSED BY:

**Colorado Section — American Chemical Society
&
Society for Applied Spectroscopy**

CONFERENCE CHAIR:

Kurt W. Zilm
Yale University, Department of Chemistry
PO Box 20817
New Haven, CT 06520-8107
Ph: 203-432-3956 • Fax: 203-432-6144
kurt.zilm@yale.edu

EPR SCIENTIFIC COMMITTEE:

Dane McCamey – Chair
University of New South Wales
Songi Han – Co-Chair 2023, Chair 2024
University of California Santa Barbara

Claudia Avalos
New York University

Christoph Boehme
University of Utah

Sandra Eaton - ex-officio
University of Denver

Mrignayani Kotecha
O2M Technologies

Petr Neugebauer
Central European Institute of Technology

Shekar Ramanathan
Dartmouth University

Sunil Saxena
University of Pittsburgh

CONFERENCE SUPPORTERS & EXHIBITORS *(As of July 7, 2023)*

Bridge 12 Technologies, Inc.

Bruker

Cold Technologies, Inc.

Cryogenic US LLC

National High Magnetic Field Laboratory

O2M Technologies, LLC

Rotunda Scientific Technologies

Spinflex Technologies

Virginia Diodes, Inc.

ROCKY MOUNTAIN CONFERENCE INFORMATION

REGISTRATION

Admission to all technical sessions and the exhibition is by name badge only. Registration materials may be picked up at the RMC MR registration area located at the Sonesta Denver Downtown between 12:00 p.m. and 5:00 p.m. on Sunday, July 23 or 8:00 a.m. and 5:00 p.m. anytime Monday, July 24 through Thursday, July 27.

EXHIBITION SCHEDULE

Monday, July 24

10:00 a.m. – 7:00 p.m.

(Conference Reception 5:30 p.m. – 7:00 p.m.)

Tuesday, July 25

10:00 a.m. – 4:00 p.m.

Wednesday, July 26

10:00 a.m. – 4:00 p.m.

CONFERENCE RECEPTION

Monday evening from 5:30 p.m. to 7:00 p.m., all attendees are cordially invited to join in on beverages and hors d'oeuvres. Unwind from the day's events and continue the "Rocky Mountain Conference" experience.

CONFERENCE BANQUET & AWARDS CEREMONY

Wednesday evening from 7:00 p.m. to 9:00 p.m. in The Range Ballroom. Enjoy an evening of comradeship, fine food and recognition of peers. Pre-registration required.

MESSAGES

Messages will be accepted and posted on the message board. Call 800-996-3233 or 303-690-3233 to leave messages.

SOCIAL MEDIA

Follow us on Facebook (rockymtnconf) or Twitter (@rockymtnconf) and join in the conversation.

CONFERENCE-AT-A-GLANCE

EVENT	LOCATION	Sunday		Monday		Tuesday		Wednesday		Thursday	
		a.m.	p.m.	a.m.	p.m.	a.m.	p.m.	a.m.	p.m.	a.m.	p.m.
Bruker EPR Users' Meeting	<i>University of Denver (Olin Hall)</i>										
Workshops	<i>The Range Ballroom</i>										
Conference Banquet & Awards Ceremony	<i>The Range Ballroom</i>										
EPR Lectures	<i>Oxford/Pikes Peak/ Humboldt</i>										
EPR Posters	<i>Torrey's/Oxford</i>										
Exhibition	<i>Ballroom Pre-Function</i>										

SONESTA DENVER DOWNTOWN MEETING SPACE

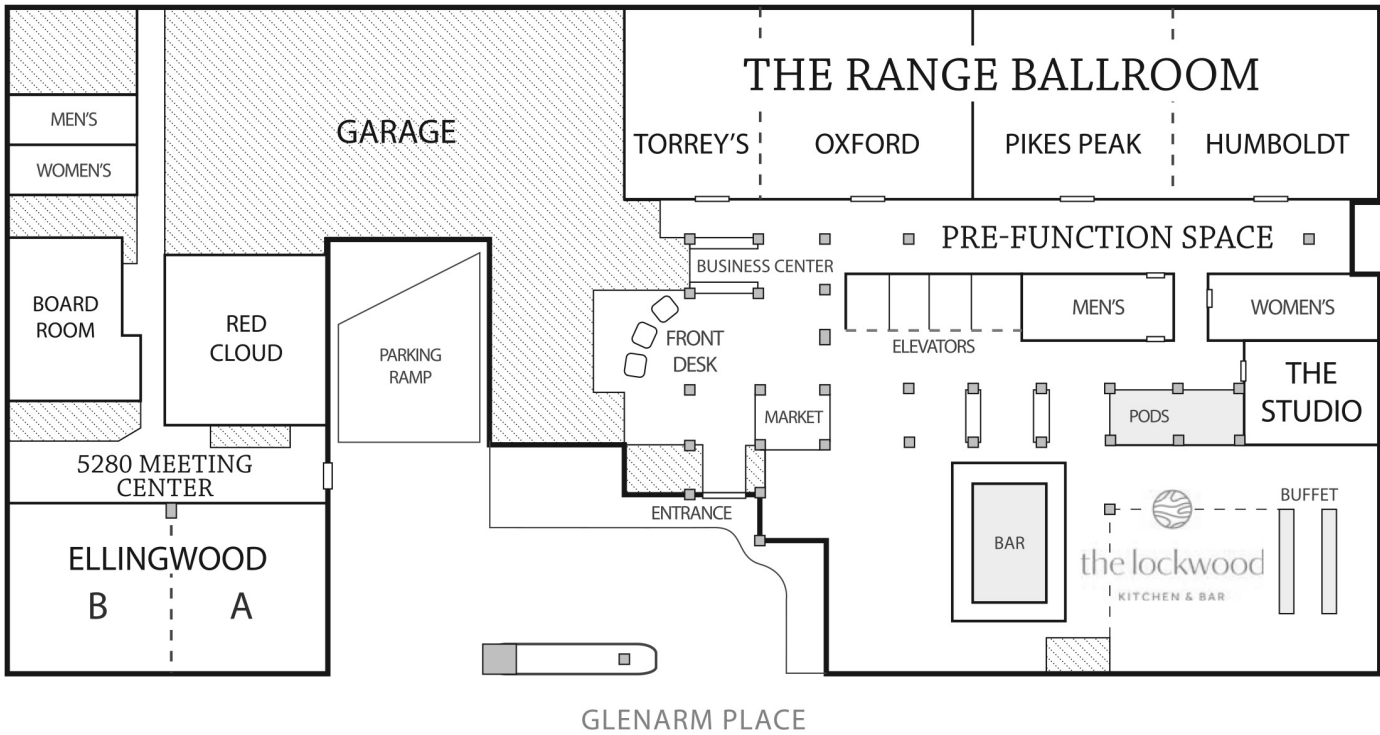

EXHIBITORS

Bridge12 Technologies, Inc • Booth 6
 11 Michigan Dr St 2, Natick, MA 01760
 Phone: 508-532-8699
 E-mail: info@bridge12.com
 Web: www.bridge12.com



ColdEdge Technologies Inc • Booth 7
 905 Harrison St Ste 146, Allentown, PA 18103
 Phone: 610-628-6363
 E-mail: coldedge@coldedget4ech.com
 Web: www.ColdEdgeTech.com



Bruker BioSpin • Booth 4 & 5
 15 Fortune Dr, Billerica, MA 01821
 Phone: 978-667-9580
 Web: www.bruker.com



Rotunda Scientific Technologies • Booth 3
 3732 Fishcreek Rd Ste 913, Stow, OH 44224
 Phone: 330-906-3403 • Fax: 330-294-0078
 E-mail: info@RotundaSciTech.com
 Web: www.RotundaSciTech.com



44TH INTERNATIONAL EPR SYMPOSIUM

July 23–27, 2023

62ND ROCKY MOUNTAIN CONFERENCE ON MAGNETIC RESONANCE

July 23–25, 2023

Denver, Colorado

CONFERENCE CHAIR

Kurt W. Zilm

EPR SYMPOSIUM COMMITTEE

Dane McCamey (Chair)

Songi Han (Co-Chair 2023, Chair 2024)

Claudia Avalos, Christoph Boehme, Sandra Eaton,
Mrignayani Kotecha, Petr Neugebauer, Shekar Ramanathan,
Sunil Saxena

EPR SYMPOSIUM SPONSORS

Bridge12 Technologies, Inc.

Bruker

ColdEdge Technologies, Inc.

Cryogenic US LLC

National High Magnetic Field Lab

O2M Technologies, LLC

Rotunda Scientific Technologies

Spinflex Instruments

Virginia Diodes, Inc.

REGISTRATION

Register at www.rockychem.com

Admission to all technical sessions and the exhibition is by name badge only. Registration materials may be picked up at the RMCMR registration area located at the Sonesta Denver Downtown between 12:00 p.m. and 5:00 p.m. on Sunday, July 23 or 8:00 a.m. and 5:00 p.m. anytime Monday, July 24 through Thursday, July 27.

EVENTS

Bruker EPR Users' Meeting:

Sunday, July 21

(University of Denver – Olin Hall)

Shuttle bus departs Sonesta Denver
Downtown at 5:00 p.m.

For information and registration access:

<https://www.bruker.com/events/rmc.html>

Poster Sessions:

Monday, July 22

7:00 p.m. – 9:00 p.m. (Torrey's/Oxford)
and

Tuesday, July 23

7:00 p.m. – 9:00 p.m. (Torrey's/Oxford)

Conference Banquet & Awards

Ceremony: Wednesday, July 24

7:00 p.m. – 9:00 p.m. (The Range Ballroom)

*Enjoy an evening of comradeship, fine food
and recognition of peers. Pre-registration
required.*

EPR SYMPOSIUM ORAL SESSIONS AGENDA

SUNDAY, JULY 23, 2023

Pre-Conference Activities	
12:30 PM - 2:30 PM	Workshop: Resonator Design (including Open PCBLGR). <u>Thorsten Maly</u> , Bridge 12 Technologies, Inc.
2:45 PM - 4:45 PM	Workshop: EasySpin. <u>Stefan Stoll</u> , University of Washington
5:30 PM	Bruker EPR Users' Group Meeting at University of Denver

MONDAY, JULY 24, 2023

8:45 AM	Welcoming Remarks – Dane McCamey	
Metals in Biology		Dane McCamey, Chair
8:55 AM	100	From Molecular-level EPR Data to Drug Development. <u>Sharon Ruthstein</u> , Bar Ilan University
9:25 AM	101	Application of Pulsed EPR Methods to Interrogate Structure-function Relationships within a Thiol Dioxygenase Enzyme-substrate Complex. <u>Brad S. Pierce</u> , University of Alabama
9:45 AM	102	Biological Radical Initiation by Radical SAM Enzymes. <u>Hao Yang</u> , Northwestern University
10:05 AM	103	Two-dimensional Reconstruction of Distance Distributions in Pulsed Dipolar Spectroscopy. <u>Madhur Srivastava</u> , Cornell University
10:25 AM	<i>Break</i>	
Methods 2 Bio		Sharon Ruthstein, Chair
10:45 AM	104	Revealing the Basis of a Genetic Disease Using DEER EPR on a Recreated Organelle. <u>Glenn L. Millhauser</u> , University of California Santa Cruz
11:15 AM	105	Capturing an Elusive Seconds-timescale Conformational Change using Cu(II)-based EPR Coupled with Atomistic MD Simulations. <u>Xiaowei Bogetti</u> , University of Pittsburgh
11:35 AM	106	Recent Advancements in DEER Sensitivity for Site-Directed Cu(II) Spin Labels. <u>Josh Casto</u> , University of Pittsburgh
11:55 AM	107	Molecular Determinants of the Sidechain Protonation State and T-Cell Receptor Assembly. <u>Tatyana I. Smirnova</u> , North Carolina State University
12:15 PM	<i>Lunch</i>	
IES Fellow Award Session		Marty Pagel, Chair
01:30 PM	108	Biologic Confirmation of Pulse Spin Lattice Relaxation EPR pO₂ Images. <u>Howard Halpern</u> , University of Chicago
Spin Devices		Marty Pagel, Chair
02:00 PM	109	Electrical Detection of Monochromatic Multi-photon Resonances in a Two-level Spin System Through Magnetic Resonance Spectroscopy with OLEDs. <u>Sabastian I. Atwood</u> , University of Utah
02:20 PM	110	Coherent Spin–Electric Coupling in Molecular Nanomagnets Revealed by EPR. <u>Junjie Liu</u> , University of Oxford

02:50 PM		<i>Break</i>
IES Silver Medal + Bio Materials		Sunil Saxena, Chair
03:20 PM	111	Native Membrane Environment Alters Protein Allostery and Structure in Outer Membrane Bacterial Transporters. <u>David S. Cafiso</u> , University of Virginia
03:50 PM	112	TBA <u>Gail Fanucci</u>
04:10 PM	113	A DNA Unwinding Equilibrium Serves as a Checkpoint for CRISPR-Cas12a Target Discrimination. <u>Peter Z. Qin</u> , University of Southern California
04:30 PM	114	Application of T₁-edited DEER to Resolve Monomer- and Oligomer-specific Distances in β_1-adrenergic Receptor and Huntingtin Protein. <u>Thomas Schmidt</u> , National Institutes of Health
5:30-7:00 PM		Conference Reception (included with registration)
Posters		
7:00-9:00 PM		Authors Present for Posters Labeled A

TUESDAY, JULY 25, 2023

Methods 2 Bio.		Thomas Schmidt, Chair
8:45 AM	115	Evaluating Lung Redox Status in Acute Lung Injury: EPR Imaging as a Tool for Biomedical Research and Clinical Applications. <u>Hanan Elajaili</u> , University of Colorado Anschutz Medical Campus
9:15 AM	116	A 'Model Kit' for Understanding Orientational Selectivity in Cu(II)-based Distance Measurements. <u>Zikri Hasanbasr</u> , University of Pittsburgh
9:35 AM	117	Molecular Mechanism of Activation of AsLOV2: Role of Hydration Water? <u>Shiny Maity</u> , University of California Santa Barbara
9:55 AM	118	Estimation of Relaxation Times on the Coherent Pathways, $p = +1$ and $p = -1$, During Free Evolution on the SECSY Signal of an Electron-nuclear Spin-coupled System in a γ-irradiated Malonic Acid Single Crystal. <u>Sushil. K. Misra</u> , Concordia University
10:15 AM		<i>Break</i>
Spin Centres 1 - NV		Christoph Boehme, Chair
10:55 AM	119	14 T DNP and EPR of PI Centers in Diamonds. <u>Ilija Kaminker</u> , Tel-Aviv University
11:25 AM	120	Diamond NVs as a Playground for Quantum Cavity-spin Dynamics at Ambient Conditions. <u>Aharon Blank</u> , Technion - Israel Institute of Technology
11:45 AM	121	Maser Threshold Characterization by Resonator Q-Factor Tuning. <u>Christopher W. M. Kay</u> , University College London, Saarland University
12:05 AM	122	Investigation of Intrinsic Linewidths in NV-detected ¹³C NMR at 4.2 Tesla. <u>Yuhang Ren</u> , University of Southern California
12:25 PM		<i>Lunch</i>
Spin NV + Spin Fission		Chair - Leah Weiss
1:30 PM	123	TBA Victor Acosta
2:00 PM	124	Luminescent Organic Radicals. <u>Sebastian Gorgon</u> , University of Cambridge, University of Oxford
2:20 PM	125	Quintet and Triplet Dynamics in Intramolecular Singlet Fission of Diphenylhexatriene Oligomers. <u>Jeannine Grünen</u> , University of Cambridge

2:40 PM	126	Transient EPR and Transient Absorption Spectroscopy of Pentacene-Nitroxide Derivatives. <u>Trent A. McHenry</u> , New York University
3:00 PM		<i>Break</i>
Spin – Undefined		Jonathan Friedman, Chair
3:30 PM	127	Developing Optically Addressable Molecular Qubits for Quantum Technologies. <u>L.R.Weiss</u> , University of Chicago, Tohoku University
4:00 PM	128	High-Field Pulsed EPR for Spin Population Transfer in a Gd³⁺ Molecular Crystal. <u>M.V.H. Subramanya</u> , National High Magnetic Field Laboratory, Florida State University
4:20 PM	129	ESR Characterization of Zero-Field Clock Transitions in Silica-Glass Defects. <u>Brendan C. Sheehan</u> , Amherst College, University of Massachusetts Amherst
4:40 PM	130	Spin–Electric Coupling in a Copper(II)-Based Spin Triangle Revealed by Electric-Field-Modulated Electron Paramagnetic Resonance Spectroscopy. <u>Maria Fittipaldi</u> , University of Florence
Posters		
7:00-9:00 PM		Authors Present for Posters Labeled B

WEDNESDAY, JULY 26, 2023

Materials I.		Chair - Aharon Blank
8:55 AM	131	In situ EPR Investigation of Oxygen Vacancies Induced Ferrimagnetism in Metal Oxide Catalysts. <u>Mikhail Agrachev</u> , ETH Zurich
9:15 AM	132	EPR Study of Charge Transfer Co-crystals of Perylene/TCNQ, Anthracene/TCNQ and DBTTF/F4TCNQ. <u>Raanan Carmielli</u> , Weizmann Institute of Science
9:35 AM	133	Clock Transition and ESEEM in the Cr⁷Mn Molecular Nanomagnet. <u>Guanchu Chen</u> , Amherst College, University of Massachusetts Amherst
9:55 AM	134	<u>Stephen Hill</u> , Florida State University
10:15 AM		<i>Break</i>
Materials 1- Methods 1		Claudia Avalos, Chair
10:55 AM	135	Dinuclear Cr(III) Complexes with Uncommon Bridges and the Importance of the Biquadratic Exchange Interactions. <u>Andrew Ozarowski</u> , National High Magnetic Field Laboratory
11:15 AM	136	Multifrequency Electrically Detected Magnetic Resonance Setup based on a sub-THz FraScan Spectrometer. <u>Artur Solodovnyk</u> , Pennsylvania State University, Brno University of Technology
11:35 AM	137	Patches and Pockets of Weird Water: New Frontiers for ODNP. <u>John M. Franck</u> , Syracuse University
11:55 AM	138	Improving Sensitivity of Distance Measurements at Nanomolar Protein Concentrations using Double Quantum Coherence. <u>Alysia Mandato</u> , University of Pittsburgh
12:15 PM		<i>Lunch</i>
Methods 1		John Marohn, Chair
1:30 PM	139	Can Magnetic Resonance Force Microscopy Detect and Image Individual Nitroxide Spins? <u>John A. Marohn</u> , Cornell University
1:50 PM	140	Demonstration of Electrically Detected Magnetic Resonance and Near Zero Field Magnetoresistance in Packaged SiC MOSFETs. <u>Colin G. McKay</u> , Sandia National Laboratories

2:10 PM	141	Rapid scan ESR: A Versatile Tool for the Spin Relaxation Studies at (sub)THz Frequencies. <u>P. Neugebauer</u> , Brno University of Technology
2:30 PM	142	Time-Frequency Analysis of Two-Dimensional Electron Spin Resonance Signals. <u>Gyana Ranjan Sahoo</u> , Cornell University
2:50 PM		<i>Break</i>
Methods 1		Chair - Mark Sherwin
3:30 PM	143	Photonic Band Gap Resonators for mm-Wave Pulsed EPR. <u>Alex I. Smirnov</u> , North Carolina State University
3:50 PM	144	Quasi-optical Sample Holder with Order-of-magnitude Improvement in Signal to Noise Ratio for a Frequency-agile Electron Magnetic Resonance Spectrometer Powered by Free-electron Laser. <u>Antonin Sojka</u> , University of California, Santa Barbara
4:10 PM	145	1 GHz EPR Imaging of Small Numbers of Nitroxide Spins Using Rapid Scan Direct Detection. <u>Lukas B. Woodcock</u> , University of Denver
7:00-9:00 PM		Conference Banquet & Awards Ceremony <i>(Enjoy an evening of comradeship, fine food and recognition of peers. Pre-registration required.)</i>
8:00 PM		Welcoming Remarks.
8:05 PM		David S. Cafiso

THURSDAY, JULY 27, 2023

Methods 2 Bio		Boris Epel, Chair
8:55 AM	146	Rapid-Scan-Enabled Time-resolved Gd-Gd EPR for “Filming” a Protein at Physiological Temperatures. <u>Brad D. Price</u> , University of California Santa Barbara
9:15 AM	147	A Simulation Independent Wavelet-Based Approach for cw ESR Spectral Analysis. <u>Aritro Sinha Roy</u> , Cornell University
9:35 AM	148	Site Directed Spin Labeling and Integrative Protein Modeling with chiLife. <u>Stefan Stoll</u> , University of Washington
9:55 AM	149	A Wavelet-based Approach to Background Correction in Pulsed Dipolar Spectroscopy. <u>Karen Tsay</u> , University of California Santa Barbara
10:15 AM		<i>Break</i>
EPR Imaging		Howard Halpern, Chair
10:45 AM	150	Oxygen Enhanced EPR Imaging for Evaluations of Radiotherapy in Preclinical Tumor Models. <u>Mark D. Pagel</u> , University of Texas MD Anderson Cancer Center
11:15 AM	151	Behind BBB: Trityl-based Oxygen Imaging of Systemic Neuroinflammation in Mice. <u>Boris Epel</u> , The University of Chicago
11:35 AM	152	Nondestructive, Longitudinal, 3D Cell Viability Assessment in a Multi-Well Plate System Using EPR Oxygen Imaging. <u>Mrignayani Kotecha</u> , O2M Technologies, LLC
11:55 AM	153	A Data Processing Approach for High Resolution Electron Spin Resonance Imaging. <u>Nimesh Srivastava</u> , Cornell University

62ND ROCKY MOUNTAIN CONFERENCE ON MAGNETIC RESONANCE

44TH INTERNATIONAL EPR SYMPOSIUM POSTER PRESENTATIONS

MONDAY, JULY 24 • 7:00–9:00 p.m.
(Authors Present for Posters Labeled A)

TUESDAY, JULY 23 • 7:00–9:00 p.m.
(Authors Present for Posters Labeled B)

A	200	Towards Spectroscopic Observation of Electric Field-Effects on Molecular Nanomagnets. <u>Francisca Abdo Arias</u> , Amherst College
B	201	A Preliminary Study on the Spin Sensitivity of Near Zero Field Magnetoresistance Spectroscopy. <u>Elijah A. Allridge</u> , Penn State University
A	202	Electron Spin Relaxation of the SO₂- and SO₃- Radicals in Na₂S₂O₄, Na₂S₂O₅, and K₂S₂O₅. <u>Georgina Amassah</u> , University of Denver
B	203	Capturing an Elusive Seconds-timescale Conformational Change using Cu(II)-based EPR Coupled with Atomistic MD Simulations. <u>Xiaowei Bogetti</u> , University of Pittsburgh
A	204	DEER Spectroscopy Demonstrates the Link Between Conformational Heterogeneity and the Signaling Efficacy and Bias of Ligands for the beta-2-adrenergic Receptor (β2AR). <u>Patrick C. Brennan</u> , Medical College of Wisconsin
B	205	Ground, Ping, Ring, Loop – Estimating Magnetic Field Fluctuations Near a Ferromagnet. <u>Russell W. Burgett</u> , Cornell
A	206	Spectral Simulation and Spin Quantitation for Nitroxide Radicals in Mouse Lungs at L-band. <u>Autumn Canny</u> , University of Denver
B	207	Recent Advancements in DEER Sensitivity for Site-Directed Cu(II) Spin Labels. <u>Josh Casto</u> , University of Pittsburgh
A	208	EPR and DFT Studies of Iron, Cobalt, and Nickel Compounds That Feature a Phosphine-Substituted Bis(imino)pyridine Chelate. <u>Marco Flores</u> , Arizona State University
B	209	Maximizing Modern CW EPR: Overmodulation via Regularization. <u>John M Franck</u> , Syracuse University
A	210	Defining The Conformational Landscape Governing Ligand-Mediated β2 Adrenergic Receptor Signaling Using Pressure Resolved Double Electron Electron Resonance (PRDEER) Spectroscopy. <u>Alexander M. Garces</u> , Medical College of Wisconsin
B	211	Electron Paramagnetic Resonance of Actinide Coordination Complexes. <u>Samuel M. Greer</u> , Los Alamos National Laboratory
A	212	Characterization of Protein Conformational Exchange Kinetics Using Pressure-jump EPR. <u>Julian D. Grosskopf</u> , Medical College of Wisconsin
B	213	Optically Detected Magnetic Resonance on Optoelectronic Systems. <u>Jeannine Grüne</u> , University of Cambridge, University of Wuerzburg
A	214	A ‘Model Kit’ for Understanding Orientational Selectivity in Cu(II)-based Distance Measurements. <u>Zikri Hasanbasri</u> , University of Pittsburgh

B	215	Development of a Pre-Clinical 1 GHz EPR Imager. <u>Tanden A. Hovey</u> , University of Denver
A	216	Overhauser DNP Solvent Dynamics Measurements of Binary Mixtures. <u>Timothy J. Keller</u> , Bridge12 Technologies, Inc.
B	217	A Novel Simulation Strategy Facilitates the Design of Resonator Coupling -- An Application to ODNP. <u>Warren F. Kincaid</u> , Syracuse University
A	218	The Control of Catalytic Reactivity in [FeFe]-hydrogenases Examined Through Multifrequency CW and Pulse EPR. <u>Effie C. Kisgeropoulos</u> , National Renewable Energy Laboratory
B	219	Assessment of Blood-Brain-Barrier Leakage and Brain Oxygenation in Connexin-32 Knockout Mice with Systemic Neuroinflammation Using EPR Imaging. <u>Mrignayani Kotecha</u> , O2M Technologies, LLC
A	220	Characterization of Mn²⁺-substituted Cyclic GMP-AMP Synthase (cGAS). <u>Molly M. Lockart</u> , Samford University
B	221	Impact of Metal-Organic Framework (MOF) Crystallinity on Enzyme Orientation and Dynamics. <u>Austin L. MacRae</u> , North Dakota State University
A	222	Improving Sensitivity of Distance Measurements at Nanomolar Protein Concentrations using Double Quantum Coherence. <u>Alysia Mandato</u> , University of Pittsburgh
B	223	The Landau-Zener-Stückelberg-Majorana Transition in the T₂ << T₁ Limit. <u>John A. Marohn</u> , Cornell University
A	224	Investigating Role of Nuclear Spin Patterning and Counterion on Spin Relaxation in V(IV) Complexes. <u>Roxanna Martinez</u> , <u>Colorado State University</u>
B	225	A Versatile Setup for FTIR Spectroscopy in High Magnetic Fields. <u>Petr Neugebauer</u> , Brno University of Technology
A	226	Spin-Correlated Radical Pairs in Quantum Dot-Organic Molecule Conjugates. <u>Jens Niklas</u> , Argonne National Laboratory
B	227	The Loop-zag Resonator: A Loop-gap Resonator Design for Improved Sensitivity in Electron-spin Resonance Experiments. <u>Brendan C. Sheehan</u> , Amherst College, University of Massachusetts Amherst
A	228	Characterization of Free Radical Intermediates Generated by Nanoparticle Additives to Oil-based Lubricants. <u>Tatyana I. Smirnova</u> , North Carolina State University
B	229	Investigating Methyl-driven Electron Spin Decoherence. <u>Stefan Stoll</u> , University of Washington
A	230	Spectroscopic investigation of Mn(II)-Dependent Enzyme from Rhodospirillum rubrum. <u>Rachelle Stowell</u> , University of Washington
B	231	A High-Volume Resonator for Continuous Flow Dynamic Nuclear Polarisation. <u>Daniel J. Sung</u> , University of St Andrews
A	232	HiPER - A High Sensitivity AWG EPR/DNP Spectrometer. <u>Daniel Sung</u> , University of St Andrews
B	233	Modulating Berry-Phase Interference Using a Pneumatic-Pressure Based Probe. <u>Kobe Thompson</u> , Amherst College
A	234	Chemical Mimicry: Designing Magnetic Nuclei to Act Like Electrons. <u>Okten Ungor</u> , Colorado State University
B	235	The Role of a Conserved Ionic Lock in Transport by an Outer Membrane Protein. <u>Viranga W Wimalasiri</u> , University of Virginia

100 From Molecular-level EPR Data to Drug Development

Sharon Ruthstein

The Chemistry Department and the Institute of Nanotechnology and Advanced Materials, Faculty of Exact Sciences, Bar Ilan University, Israel

In the last couple of years, my lab has been exploring the cellular copper cycle in eukaryotic and prokaryotic systems using Electron Paramagnetic Resonance (EPR) spectroscopy.

While most of the proteins involved in the copper cycle are believed to be known, as well as some of the crystal structures, there is still lack of information on the kinetic and the transfer mechanism of the copper in the cellular environment. Since dysfunction of the copper regulation system can lead to neurological diseases, cancer, and to the cell death, it is essential to understand every little detail in the copper cycle to be able to control it according to specific needs.

EPR has become a powerful tool for studying complex dynamic biological systems since it is not limited to the protein size and does not require crystallization. Hence, the biological system can be studied in solution, lipids, and even the cellular environment.

In our group, we are applying various EPR measurements together with computations, biochemistry experiments, CD and NMR to identify the copper binding sites, as well as to understand how one protein in the cycle coordinated to another protein to transfer the metal ion. We target the conformational changes that occur in each protein, and we aim to gain also important information on the transfer mechanism.

In this talk, I will present our recent results on the copper transfer mechanism in eukaryotic systems. I will then demonstrate how basic understanding of the function of these systems can assist us in designing novel therapeutic and diagnostic compounds

EPR ORAL SESSION

Sharon Ruthstein, Bar Ilan University, Anna and Max Web., Ramat Gan, Tel Aviv, 5290002, Israel

E-mail: sharon.ruthstein@biu.ac.il

101 Application of Pulsed EPR Methods to Interrogate Structure-function Relationships within a Thiol Dioxygenase Enzyme-substrate Complex

Allison N. Schmittou¹, Nick J. York¹, Molly M. Lockart², and Brad S. Pierce¹

1. Department of Chemistry and Biochemistry, The University of Alabama, 250 Hackberry Lane, Tuscaloosa, AL 35487, USA

2. Department of Chemistry and Biochemistry, Samford University, 800 Lakeshore Drive, Homewood, AL 35229, USA

Mercaptopropionic acid (3MPA) dioxygenase (MDO) is a mononuclear non-heme iron enzyme that catalyzes the O₂-dependent formation of sulfinates from sulfhydryl-containing amino acid derivatives. A conserved feature among small molecule thiol dioxygenases is a sequence of outer Fe-coordination sphere amino acids (Ser, His, and Tyr) positioned adjacent to the iron site. For simplicity, these residues are collectively referred to as the SHY-motif. While the functional role of the SHY-motif is poorly understood, it has been observed that disruptions in their H-bonding network have a considerable impact on catalytic rate. For instance, the H157N MDO variant exhibits a ~20-fold decrease in k_{cat} relative to wild-type enzyme. While x-ray crystal structures for the MDO-3MPA complex are unavailable, we recently reported a structure for MDO in complex with a substrate analog and competitive inhibitor, 3-hydroxypropionic acid (3HPA). In this work, computational studies performed on the (3MPA/NO)-MDO ternary complex were validated by hyperfine sublevel correlation spectroscopy (HYSCORE) and ⁵⁷Fe-Mössbauer experiments to corroborate an equivalent, bidentate coordination of the native 3MPA-substrate. However, H-bonding interactions between the SHY-motif and the Fe-site could not be resolved in this study due to overlapping dipolar couplings within the ¹H HYSCORE region. Instead, we demonstrate here that pulsed electron-nuclear double resonance (ENDOR) experiments resolve differences in the SHY-motif H-bonding network between wild-type MDO and the H157N variant. These experiments also reveal 1H couplings of individual protons on the 3MPA-substrate through comparison of produced from fully deuterated (2,2,3,3-²H-3MPA) and selectively ²H-C2 labeled (2,2-²H-3MPA) substrate. Among other findings, this work demonstrates the +7 kJ•mol⁻¹ increase in the rate-limiting activation barrier (DH^\ddagger) for the H157N variant relative to WT MDO can almost entirely be attributed to the reorientation of the Tyr159 H-bond to favor donation to the Asn-residue rather than to the axial NO-bound Fe-position.

EPR ORAL SESSION

Brad S Pierce, The University of Alabama, 250 Hackberry Lane, Tuscaloosa, Alabama, 35487, United States

Tel: 2053488445, E-mail: bspierce1@ua.edu

102 Biological Radical Initiation by Radical SAM EnzymesHao Yang,¹ Joan B. Broderick,² Brian M. Hoffman¹

1. Northwestern University

2. Montana State University

Radical SAM(RS) enzymes utilize cofactor [4Fe-4S] cluster and SAM to generate 5'-dAdo• radical for initiating the broadest range of radical chemistry in biology. This talk will detail our recent work in illustrating the radical initiation mechanism of RS enzymes through the discovery of the photoinduced electron transfer activity from a reduced [4Fe-4S]¹⁺ cluster to SAM among RS enzymes. The photoinduced electron transfer within the [4Fe-4S]¹⁺/SAM complex in one RS enzyme HydG reductively cleaves the S-CH₃ bond of SAM, a wrong bond cleavage that nature never does for liberating •CH₃, while the photoinduced electron transfer in another RS enzyme PFL-AE leads to the reductive S-C5' bond cleavage, which trapped and characterized 5'-dAdo• that had remained illusive for the last half century. Much to our surprise, our EPR/ENDOR/ESEEM spectroscopies and DFT calculations revealed that 5'-dAdo• trapped in the enzyme's active site is chaperoned by interactions with its adjacent methionine-bound [4Fe-4S]²⁺ cluster. In addition, we observed a substantial motion of 5'-dAdo• towards the unique Fe of the [4Fe-4S]²⁺ cluster upon formation of 5'-dAdo•, plausibly an initial step towards the formation of the Fe-C5' bond of the Ω organometallic intermediate. The trapping and characterization of •CH₃ and 5'-dAdo• within RS enzymes through photoinduced electron transfer strengthened the mechanistic understanding of RS enzymes in taming the broadest radical chemistry in biology.

EPR ORAL SESSION

Hao Yang, 2145 Sheridan Rd, Evanston, Illinois, 60208, United States

E-mail: hao.yang1@northwestern.edu

103 Two-dimensional Reconstruction of Distance Distributions in Pulsed Dipolar SpectroscopyThomas Schmidt,¹ Jack H. Freed,^{2,3} Marius Clore,¹ Madhur Srivastava^{2,3}

1. Laboratory of Chemical Physics, National Institute of Diabetes and Digestive and Kidney Diseases, Bethesda, MD 20892 USA

2. Department of Chemistry and Chemical Biology, Cornell University, Ithaca, NY 14853, USA

3. National Biomedical Resource for Advanced ESR Spectroscopy, Cornell University, Ithaca, NY 14853 USA

Revealing protein structural evolution is essential for determining its function and interaction with the environment, for understanding disease mechanisms. However, it is challenging for biophysical methods to observe structure evolution, especially at longer distances, limiting their application to few biological systems. Pulsed Dipolar Electron Spin Resonance Spectroscopy (PDS) is powerful method for obtaining such information between the distance ranges of 1 to 10 nm. In PDS, a dipolar signal is acquired from the interaction between a pair of spin labels, from which the distance distribution between them, $P(r)$ may be obtained. Pseudo two-dimensional PDS experiments, such as T_m -filtered DEER, allow one to differentiate distance populations in inter-exchanging biomolecular systems. The reconstruction, however, of 2D distributions of distance populations using existing methods (such as Tikhonov regularization or Gaussian modeling) is challenging since relating the results of successive traces requires a priori information, which may not be readily available. To overcome this problem, we introduce the 2D Srivastava-Freed Singular Value Decomposition (2D SF-SVD) method that enables reconstruction of 2D distance distributions in a straightforward fashion, thereby permitting the accurate determination of measurable population changes for each distance. That is, the distance surface one obtains contains both the distance components transformed from the dimension of the dipolar signal and the dimension of traces, revealing changes in each distance population, and hence the structure evolution. We demonstrate this approach for the analysis of T_m -filtered DEER traces of protein A labeled with either R1 or R1p nitroxide spin labels.

Supported by the NIH Intramural Funding and Cornell Internal Funding.

EPR ORAL SESSION

Madhur Srivastava, Cornell University, 259 Feeny Way, Ithaca, New York, 14850, United States

E-mail: ms2736@cornell.edu

104 Revealing the Basis of a Genetic Disease Using DEER EPR on a Recreated OrganelleTufa E. Assafa¹, Xue Guo², Liang Feng² and Glenn L. Millhauser¹

1. Department of Chemistry and Biochemistry, University of California, Santa Cruz, CA 95060

2. Department of Molecular and Cellular Physiology, Stanford University School of Medicine, Stanford, CA 94305

Within cells, proteins are degraded to release their constituent amino acids that, in turn, are incorporated into the production of new proteins. This delicate recycling process relies on very specialized transmembrane, molecular transporters. This talk will describe our DEER EPR work on the transporter cystinosin, which is critical for the translocation of the amino acid cystine. Mutations that compromise this transporter are ultimately fatal. DEER EPR experiments on cystinosin in a membrane environment that recapitulates the strong pH gradient experienced within

cells reveal the protein's functional conformations and how these are biased by disease-associated mutations.

EPR ORAL SESSION

Glenn Millhauser, University of California, Santa Cruz, Department of Chemistry and Biochemistry, Santa Cruz, California, 95064, United States
E-mail: glennm@ucsc.edu

105 Capturing an Elusive Seconds-timescale Conformational Change using Cu(II)-based EPR Coupled with Atomistic MD Simulations

Xiaowei Bogetti,¹ Anthony Bogetti,¹ Joshua Casto,¹ Gordon Rule,² Lillian Chong¹ and Sunil Saxena.¹

1. Department of Chemistry, University of Pittsburgh, Pittsburgh, Pennsylvania 15260

2. United States Department of Biological Sciences, Carnegie Mellon University, Pittsburgh, PA, 15213, USA

Pulsed EPR distance measurements using double histidine (dHis)-Cu(II) based spin labels have enabled efficient localization of a metal binding site,¹ precise determination of protein-nucleic acid interactions² and sensitive detection of conformational changes.³ However, relating the EPR distance to protein conformational changes has typically relied on computational models that are fast, but suffers from low resolution.⁴ In this talk, we discuss a new strategy that enables sampling conformational changes at atomic resolution by combining dHis-Cu(II) EPR and weighted ensemble molecular dynamics (MD) simulations. We have applied this strategy to sample a seconds-timescale conformational change in the homodimeric detoxification enzyme, human glutathione S transferase A1-1 (hGSTA1-1).^{5,6} First, we collected EPR distance distribution on a critical helix of hGSTA1-1 dimer as a function of ligand concentration. Using key information from the EPR results, we performed weighted ensemble MD simulations to generate atomistic transition pathways between the ligand-bound and newly resolved ligand-free states. Based on the simulations, the subtle change of 4 Å in the EPR distance distributions between the ligand-bound and ligand-free state surprisingly results from a large-scale conformational change. In addition, we found that the conformational transition is mutually exclusive between the two monomers within the hGSTA1-1 dimer, which suggests negative cooperativity. Such a cooperative mechanism, which is controlled by key residue-residue interactions, may be essential for the enzyme to protect cells from a broad range of toxins. This talk showcases the power of integrating EPR and atomistic enhanced MD simulation to understand the mechanism of a seconds-timescale conformational change in a functional enzyme at the atomic level.⁷

Supported by NSF MCB-2112871, NSF MRI 2117681 and Center for Research Computing at the University of Pittsburgh.

[1]. Gamble Jarvi A, Cunningham TF, Saxena S (2019) Phys. Chem. Chem. Phys. 21:10238–10243.

[2]. Sameach H, Ghosh S, Gevorkyan-Airapetov L, Saxena S, Ruthstein S (2019) Angew. Chem. 131:3085–3088.

[3]. Lawless MJ, Pettersson JR, Rule GS, Lanni F, Saxena S (2018) Biophys. J. 114:592–601.

[4]. Jeschke G (2018) Protein Sci. 27:76–85.

[5]. Zhan Y, Rule GS (2004) Biochemistry 43:7244–7254.

[6]. Nieslanik BS, Ibarra C, Atkins WM (2001) Biochemistry 40:3536–3543.

[7]. Bogetti X, Bogetti AT, Casto J, Rule GS, Chong LT, Saxena S (2023) Direct observation of negative cooperativity in a detoxification enzyme at the atomic level by EPR and simulation.

EPR ORAL SESSION

Xiaowei Bogetti, University of Pittsburgh, Chevron Science Center, 219 Parkman Ave, Pittsburgh, Pennsylvania, 15260, United States
Tel: 3022999714, E-mail: xid37@pitt.edu

106 Recent Advancements in DEER Sensitivity for Site-Directed Cu(II) Spin Labels

Josh Casto,¹ Xiaowei Bogetti,¹ Zilri Hasanbasri,¹ Alysia Mandato,¹ Nicholas Moriglioni,¹ Hannah Hunter,¹ Sunil Saxena¹

1. University of Pittsburgh, Department of Chemistry, Pittsburgh, PA, 15213

Cu(II)-based spin labels are an incisive and versatile tool in EPR to elucidate biophysical dynamics and conformational changes pertinent to biomolecular function¹. However, since nitroxide concepts do not translate directly to Cu(II), acquiring high quality data can be non-intuitive for those unfamiliar. Specifically, the innate fast relaxation times and broad EPR absorption spectrum of Cu(II) can be a sensitivity limitation for pulsed dipolar spectroscopy distance measurements¹. On the other hand, the narrow distance distributions and simple chelation labeling offered by Cu(II)-based protein labels are advantageous. These attributes permit Cu(II) labels to obtain structural details inaccessible to common nitroxide labels. In this talk we showcase recent method development aimed to alleviate sensitivity obstacles to make Cu(II) measurements more user friendly and accessible to the broader biophysical community. We demonstrate that protein and solvent deuteration dramatically improves Cu(II) sensitivity and sustains the duration of the dipolar modulated signal to 32 μs^2 . Further, incorporating 200 MHz bandwidth frequency-swept shaped pulses generated by commercial instrumentation increases measurement sensitivity even further by probing a greater portion of the Cu(II) spectrum than monochromic pulses. Additionally, orientationally averaged distances can be obtained with only two measurements by employing strategic acquisition schemes^{4,5}. When these advances in Cu(II) method development are combined we observe dramatic improvements to sensitivity that enables rapid collection of orientationally averaged

long-range measurements in under two hours and short-range distances in only minutes.

- [1] Gamble Jarvi, A.; Bogetti, X.; Singewald, K.; Ghosh, S.; Saxena, S. *Acc. Chem. Res.* 2021, 54(6), 1481-1491.
- [2] Casto, J.; Mandato, A.; Saxena, S.; J. *Phys. Chem Lett.* 2021, 12(19) 4681-4685.
- [3] Casto, J.; Bogetti, X.; Hunter, H. R.; Hasanbasri, Z.; Saxena, S. 2023, 349, 107413.
- [4] Hasanbasri, Z.; Moriglioni, N.; Saxena, S. *Phys. Chem. Chem. Phys.* 2023. [In Press]
- [5] Bogetti, X*. Hasanbasri, Z*. Hunter, H. R.; Saxena, S. *Phys. Chem. Chem. Phys.* 2022, 23, 14727.

EPR ORAL SESSION

Josh Casto, University of Pittsburgh, 6723 McPherson Blvd Apt 5, Pittsburgh, Pennsylvania, 15208, United States
Tel: 7245132413, E-mail: jac246@pitt.edu

107 **Molecular Determinants of the Sidechain Protonation State and T-Cell Receptor Assembly**

Tatyana I. Smirnova,¹ Maxim A. Voinov,¹ Sergey Milikisoyants,¹ Gabriel A. Cook,² and Alex I. Smirnov¹

1. North Carolina State University, Raleigh, NC, USA

2. Oklahoma State University, Stillwater, OK, USA

Ionization states of amino acid residues play significant roles in membrane protein assembly and function; however, they are difficult to decipher experimentally. The analysis becomes especially complicated for membrane proteins because of the dearth of data on transmembrane gradients in polarity, electric potentials, and hydration at the protein-membrane interface. Here we examine how electrostatic interactions, suggested to be essential for T-cell receptor (TCR) membrane assembly, could be manipulated by modifying the membrane lipid composition. Novel pH-sensitive ionizable EPR labels were employed to profile heterogeneous dielectric environment along the transmembrane protein-lipid interfaces. A series of model transmembrane α -helical WALP peptides was employed to derive the profile of effective pK(a) as a function of membrane depth. It was found that effective pK(a) of membrane-buried sidechains can be significantly shifted by varying the membrane surface charge density. A peptide corresponding to the transmembrane domain of TCR α was labeled with pH-sensitive nitroxide and incorporated into liposomes. EPR of this label reported on the sidechain protonation state, membrane insertion, and association of the helices within the membrane. It was found that an increase in negative charge density at the membrane surface alters the protonation state of membrane-buried ionizable sidechains in the transmembrane domain of TCR α . Double Electron-Electron Resonance (DEER) measurements quantified effect of charges on the domain agglomeration. Turning the charge of the sidechain "off" increases tendency of the transmembrane domain to agglomerate - a phenomenon that could be critical for the TCR assembly and its degradation. Overall, EPR of ionizable probes represents an informative approach for uncovering mechanisms as to how the changes in local environment along the protein-lipid interface can result in a "tunable" pKa of the ionizable sidechains and drive the structural changes in membrane proteins.

EPR ORAL SESSION

Tatyana Smirnova, North Carolina State University, 2620 Yarbrough Dr, Raleigh, North Carolina, 27695-0001, United States

Tel: 9195134375, E-mail: tismirno@ncsu.edu

108 **Biologic Confirmation of Pulse Spin Lattice Relaxation EPR pO₂ Images**

Howard Halpern, MD, PhD,^{1,3} Inna Gertsenshteyn, PhD,^{1,2,3} Mihai Giurcanu, PhD,⁵ Eugene Barth, BS,^{1,3} John Lukens, BS,^{1,3} Kayla Hall, BS,^{1,3} Jenipher Flores Martinez, BS,^{1,3} Melissa Grana, BS,^{1,3} Matthew Maggio, BS,^{1,3} Richard C. Miller, PhD,^{1,3} Subramanian V. Sundramoorthy, MS,^{1,3} Martyna Krzykawska-Serda, PhD,^{3,6} Erik Pearson, PhD,^{1,3} Bulent Aydogan, PhD,¹ Ralph R. Weichselbaum, MD,¹ Victor M. Tormyshev, PhD,⁷ Mriyayani Kotecha, PhD,⁴ Boris Epel, PhD^{1,3}

1. Department of Radiation and Cellular Oncology, The University of Chicago, Chicago, IL, USA

2. Department of Radiology, The University of Chicago, Chicago, IL, USA

3. Center for EPR Imaging In Vivo Physiology, The University of Chicago, Chicago, IL, USA

4. O2M Technologies, Chicago, IL, USA

5. Department of Public Health Sciences, The University of Chicago, Chicago, IL, USA

6. Department of Biophysics and Cancer Biology, Jagiellonian University, Kraków, Poland

7. Novosibirsk Institute of Organic Chemistry, Novosibirsk, Russia

Motivation: Locat resistant tumor regions from local hypoxia, low molecular oxygen levels, have been imaged with pulse spin lattice relaxation (SLR) based EPR 3D images of a oxygen quantifying nontoxic trityl (OX071) spin probe (EPROI) in mammalian tumors. A biologic validation of EPROI by demonstration of benefit from radiation boosts to hypoxic tumor relative to well oxygenated boosts has been demonstrated only once.

pO₂ images from 3 murine tumor directed radiotherapy to adenocarcinomas, squamous cell carcinomas, and fibrosarcomas registered with images of tumor anatomy, boost location, and pO₂ were imaged and with T2-weighted MRI, CT, and EPROI. Defining hypoxia by pO₂ 10 mmHg. Randomly directed boosts to hypoxic or well oxygenated tumor were given to animals followed for tumor recurrence. Local tumor control probability (LTCP) comparison was assessed with Kaplan-Meier analysis.

Local Tumor Control Probability increase in from Hypoxia Boost treatments vs Oxygenated Boosts in the combined cohort ($p < 0.0001$) was found with significant advantage in all three groups.

Despite confounding variation from the complex biologic object, this provides confirmatory indication of the accuracy of EPROI.

EPR ORAL SESSION

Howard J Halpern, University of Chicago, 5841 S Maryland Ave, Chicago, Illinois, 60637, United States
Tel: 7737026871, E-mail: hhalpern@uchicago.edu

109 Electrical Detection of Monochromatic Multi-photon Resonances in a Two-level Spin System Through Magnetic Resonance Spectroscopy with OLEDs

Sabastian I. Atwood,¹ Vagharsh V. Mkhitarian,² Sumitra Dhileepkumar,¹ Connor Nuibe,¹ Sanaz Hosseinzadeh,¹ Hans Malissa,² John M. Lupton,^{1,2} Christoph M. Boehme¹

1. University of Utah, Department of Physics and Astronomy, Salt Lake City, Utah 84112

2. Universität Regensburg, Institut für Experimentelle und Angewandte Physik, Regensburg, 93053 Germany

We report the detection of two- and three-photon electron spin transitions through field-swept, continuous-wave electrically detected magnetic resonance spectroscopy on organic light emitting diodes (OLEDs). The transitions are induced through monochromatic excitation of a two-level spin system so that the multi-photon resonances appear at integer multiples of the one-photon resonance. Only a handful of multi-photon resonances of that type have been reported in the literature. The required condition for nonlinear spectroscopy ($B_1/B_0 \sim 1$) is obtained by the combination of 1) an impedance-matched coil to obtain B_1 on the order of 1 mT, and 2) detecting the observable of spin-permutation symmetry among electron-hole pairs in order to reduce B_0 to the order of 1 mT without sacrificing signal-to-noise. The presence of higher amplifier-induced radio-frequency harmonics is eliminated through both a low-pass filter and the impedance-matched coil itself, while the presence of multi-photon resonances is confirmed through the analysis of the shift in resonance peaks with increasing drive power.

EPR ORAL SESSION

Sabastian I Atwood, University of Utah, 970 University Vlg, Salt Lake City, Utah, 84108, United States
Tel: 575-491-7019, E-mail: sabatwood@gmail.com

110 Coherent Spin-Electric Coupling in Molecular Nanomagnets Revealed by EPR

Junjie Liu,¹ Mikhail Vaganov,¹ Niccolo Fontana,¹ Jakub Mrozek,¹ Aman Ullah,² Yan Duan,² François Lambert,³ Talal Mallah,³ Eugenio Coronado,² Alejandro Gaita-Ariño,² Arzhang Ardavan¹

1. Department of Physics, University of Oxford, Oxford OX1 3PU, UK

2. Instituto de Ciencia Molecular (ICMol), Universitat de València, Paterna 46980, Spain

3. ICMO UMR CNRS, Université Paris-Saclay, Orsay 91405, France

Electrical control of spins at the nanoscale offers significant architectural advantages in spintronics because electric fields can be confined over shorter length scales than magnetic fields¹. This has important consequences for the design of spin-based information technologies: while the Zeeman interaction with a magnetic field provides a convenient tool for manipulating spins, it is difficult to achieve local control of individual spins on the length scale anticipated for useful quantum technologies. This motivates the study of electric field control of spin Hamiltonians. Recently, spin-electric field couplings (SEC) have been demonstrated in several molecular magnets²⁻⁴. However, SECs for those molecules are relatively weak, raising the quest of exploring the pathways for enhancing SEC through molecular engineering.

Here we investigate SECs in several molecular nanomagnets by applying electric field pulses during time-resolved EPR measurements. By identifying molecules with a significant electrical polarisability and a spin spectrum that is highly sensitive to the structural degree of freedom, we demonstrate strong SECs that generate significant perturbations to Zeeman states. Importantly, the effect of the electric field does not affect the spin coherence, making the coupling suitable for quantum information processing applications. We demonstrate coherent electrical control of the molecular spin states and independent manipulation for the two magnetically indistinguishable inversion-related molecules in the unit cell of the crystal⁵.

[1] Trif et al., Phys. Rev. Lett., **2008**, 101, 217201.

[2] Boudalis et al., Chem. Eur. J., **2018**, 24, 14896.

[3] Liu, et al. Phys. Rev. Lett., **2019**, 122, 037202.

[4] Fittipaldi et al., Nat. Mater., **2019**, 4, 329.

[5] Liu, et al. Nat. Phys., **2021**, 17, 1205.

EPR ORAL SESSION

Junjie Liu, Department of Physics, University of Oxford, Clarendon Laboratory, Parks Road, Oxford, England, OX1 3PU, United Kingdom

Tel: 44-7721370807, E-mail: junjie.liu@physics.ox.ac.uk

111 Native Membrane Environment Alters Protein Allostery and Structure in Outer Membrane Bacterial Transporters.

David S. Cafiso

Department of Chemistry and Center for Membrane Biology, University of Virginia, McCormick Road, Charlottesville, Virginia, 22904-4319

TonB-dependent transporters are a large family of outer membrane proteins (OMPs) that derive the energy for transport by coupling to the inner membrane protein TonB. This coupling involves the interaction between an N-terminal periplasmic segment in the transporter, termed the Ton box, and the C-terminal end of TonB. Despite numerous high-resolution structures, neither the structural changes that facilitate transport nor the mechanism by which TonB drives transport is known. Using site-directed spin labeling and pulse EPR spectroscopy, we have examined structural changes within the *Escherichia coli* vitamin B₁₂ transporter, BtuB, in cells and other native and reconstituted systems. In a native membrane environment, we observe structural changes upon substrate binding within the core of the protein that are not observed in purified reconstituted phospholipid bilayers. We also find that an ionic lock, acting between the protein barrel and the core region of the protein plays a pivotal role in mediating structural changes within the protein interior. These observations are not consistent with current models for transport and they suggest an alternate mechanism. BtuB is a highly allosteric protein, and the native environment appears to play an important role in populating conformational states that may be involved in transport.

Supported by NIGMS, GM035215.

EPR ORAL SESSION

David S Cafiso, University of Virginia, McCormick Road, Charlottesville VA, Virginia, 22904-4319, United States

Tel: 434-924-3067, E-mail: dsc0b@virginia.edu

112 TBA

113 A DNA Unwinding Equilibrium Serves as a Checkpoint for CRISPR-Cas12a Target Discrimination

Jaideep Singh, Kevin G. Liu, Aleique Allen, Wei Jiang, and Peter Z. Qin

Department of Chemistry, University of Southern California, Los Angeles, CA, 90089, United States

CRISPR-associated proteins such as Cas9 and Cas12a are programmable RNA-guided nucleases that have emerged as powerful tools for genome manipulation and molecular diagnostics. However, these enzymes are prone to cleavage of off-target sequences that contain mismatches between the RNA guide and DNA protospacer. In comparison to Cas9, Cas12a has demonstrated distinct sensitivity to protospacer-adjacent-motif (PAM) distal mismatches, and the molecular basis of Cas12a's enhanced target discrimination is of great interest. In this study, we investigated the mechanism of Cas12a target recognition using a combination of site-directed spin labeling, fluorescent spectroscopy, and enzyme kinetics. With a fully matched RNA guide, the data revealed an inherent equilibrium between a DNA unwound state and a DNA-paired duplex-like state. Experiments with off-target RNA guides and pre-nicked DNA substrates identified the PAM-distal DNA unwinding equilibrium as a mismatch sensing checkpoint prior to the first step of DNA cleavage. The data sheds light on the distinct targeting mechanism of Cas12a and may better inform CRISPR based biotechnology developments.

EPR ORAL SESSION

Peter Qin, Department of Chemistry, University of Southern California, 3430 S. Vermont Ave., Los Angeles, California, 90089, United States

E-mail: pzq@usc.edu

114 Application of T1-edited DEER to Resolve Monomer- and Oligomer-specific Distances in β 1-adrenergic Receptor and Huntingtin Protein.

Nina Kubatova, G Marius Clore and Thomas Schmidt.

National Institutes of Health, Laboratory of Chemical Physics, Bethesda, MD 20912

A simple method, based on inversion recovery edited double electron-electron resonance electron paramagnetic resonance (iDEER EPR) spectroscopy¹, is presented for determining distance distributions specific to the monomer and oligomer populations in heterogeneous protein samples. The method is based on the inverse relationship between T1 and the number of radicals covalently linked to protein complexes. We demonstrate the method using three different proteins: (1) an obligate monomer exemplified by the small immunoglobulin binding B domain of protein A, (2) the amylolytic huntingtin protein which passes a nucleation unit towards its fibril state, and (3) the β 1-adrenergic receptor

(β 1AR) which exists as an equilibrium mixture of monomer and dimer species whose relative populations are affected by cholate content. The information is crucial for the quantitative analysis of distance distributions involving proteins that may exist as mixtures of monomer, dimer and high order multimers under the conditions of the DEER EPR experiment and of which homogenic populations are unobtainable due to sample restraints. 1) van Wonderen et al, *Angew. Chem.* 2013. 52, 1990

Graphic:

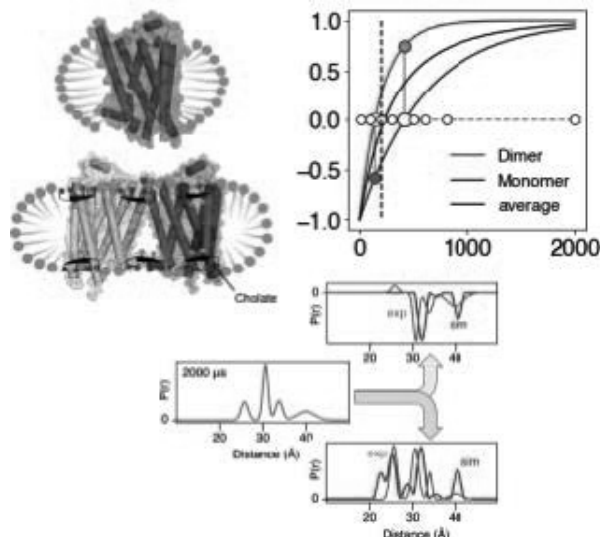

EPR ORAL SESSION

Thomas Schmidt, National Institutes of Health, 1003 Kentland Ave, Takoma Park, Maryland, 20912, United States
Tel: 2135319144, E-mail: schmidt.nedlitz.ts@gmail.com

115 Evaluating Lung Redox Status in Acute Lung Injury: EPR Imaging as a Tool for Biomedical Research and Clinical Applications

Hanan Elajaili,^{1*} Nathan Dee,¹ Lukas Woodcock,⁴ George A. Rinard,⁴ Sergey Dikalov,² Joseph Kao,³ Sandra Eaton,⁴ Gareth Eaton,⁴ Eva S. Nozik¹

1. Pediatric Critical Care Medicine, University of Colorado Anschutz Medical Campus, Aurora, CO
2. Department of Medicine, Division of Clinical Pharmacology, Vanderbilt University Medical Center
3. Department of Physiology, University of Maryland School of Medicine, Baltimore, MD
4. Department of Chemistry and Biochemistry, University of Denver, Denver, CO

Patients with hyper vs. hypoinflammatory sub-phenotypes of Acute Respiratory Distress Syndrome (ARDS) exhibit different outcomes. Hyperinflammation increases free radical production and glutathione oxidation. We aim to develop in vivo lung Electron Paramagnetic Resonance (EPR) imaging to precisely measure real time free radical production and thiol redox status in ARDS. As a first step, we developed protocols for in vivo administration of EPR probes and ex vivo imaging in a preclinical model of ARDS. In WT mice, mice lacking total body EC-SOD (KO), or overexpressing lung EC-SOD (TG), lung injury was induced with intraperitoneal (IP) lipopolysaccharide (LPS) (10/mg/kg). 24h after treatment, mice were injected IP and/or SQ as well as via intratracheal delivery (IT) with the CPH probe to detect cellular ROS, DCP-AM-H for mitochondrial ROS, or the GSH-sensitive probe (PxSSPx). Lungs were collected up to 1h after probe administration and tested by EPR at X-band; an EPR image was acquired at L-band (1GHz) by rapid scan. Cellular and mitochondrial lung ROS increased in LPS-treated lung, as measured by x-band EPR after in vivo injection of the probes. Lung cellular ROS was enhanced following LPS in KO mice and decreased in TG mice compared to WT. The cyclic form, cPxSSPx is required due to the rapid cleavage of disulfide bond of the linear form. Cellular and mitochondrial ROS was detectable in control and LPS-treated mice at L-band by EPR imaging. We successfully established protocols for in vivo treatments with EPR probes that allowed for detection of cellular and mitochondrial ROS in lung injury. The protocols differentiated between injured and uninjured mice as well as mouse strains with different disease susceptibilities. These protocols will facilitate lung EPR imaging to eventually evaluate its utility as a clinical tool to sub-phenotype patients with ARDS based on lung redox status.

EPR ORAL SESSION

Hanan Elajaili, University of Colorado, 12700 East 19th Ave. , Aurora, Colorado, 80045, United States
E-mail: hanan.elajaili@cuanschutz.edu

116 A 'Model Kit' for Understanding Orientational Selectivity in Cu(II)-based Distance Measurements

Zikri Hasanbasri¹, Xiaowei Bogetti¹, Hannah Hunter¹, Nicholas Moriglioni¹, Sunil Saxena¹

1. University of Pittsburgh, Department of Chemistry, Pittsburgh, PA 15213

Pulsed-Dipolar Spectroscopy techniques primarily probe the magnetic dipolar interactions between two spins. Techniques that probe short-range interactions (ref) can characterize the local environments of a spin, while techniques that focus on long-range interactions (ref) can provide structural constraints within a biomolecule. However, for many paramagnetic metals such as Cu(II), Co(III), Fe(II), etc., a single pulse with limited bandwidth selectively samples only a small subset of orientations of the spins. This phenomenon, dubbed orientational selectivity, can bias the dipolar signal in manners unique to each sample, making the interpretation of the data difficult. While analytical approximations and global fitting tools have been successful in accounting orientational selectivity, we lack the ability to dissect how orientational selectivity affects the dipolar signal between two spins for a given pulsed technique. Here, we highlight an approach to dissect orientational selectivity by generating an in-silico sample of a Cu(II)-labeled protein to evaluate Cu(II)-based Double Electron-Electron Resonance (DEER) experiments at Q-band frequencies^{1,2}. The in-silico sample allows the identification of Cu(II) spins excited by a specific pulse and the extraction of the dipolar signal for different experimental parameters. More importantly, the in-silico sample allows comprehensive exploration of different samples with various organizations of the two spins. With the direct observation of how the orientations of the spins contribute to the dipolar signal, we obtained optimal acquisition schemes to mitigate orientational effects and extract only the distance between two Cu(II) labels. Additionally, we show that this orientational-averaging scheme can be done with commercially available instrumentations. Finally, we experimentally validate the averaging scheme on three different protein samples. Overall, we showcase a new approach for dissecting orientational selectivity and designing optimal acquisition schemes adaptable to other rigid spin labels and pulsed techniques.

Supported by NSF BSF MCB-2006154

[1] Bogetti, Hasanbasri, Hunter, Saxena, PCCP, 2022, 24, 14727-14739

[2] Hasanbasri, Moriglioni, Saxena, PCCP, 2023, DOI: 10.1039/d3cp00404

EPR ORAL SESSION

Zikri Hasanbasri, University of Pittsburgh, 219 Parkman Ave, Pittsburgh, Pennsylvania, 15213, United States

Tel: 4062181186, E-mail: zih12@pitt.edu

117 Molecular Mechanism of Activation of AsLOV2: Role of Hydration Water?

Shiny Maity¹, Hannah Russell², Raj Chaklashiya¹, Jinlei Cui¹, Janet E. Lovett², Mark S. Sherwin³ and Songi Han¹

1. University of California Santa Barbara, Department of Chemistry and Biochemistry, Santa Barbara, CA 93106

2. University of St. Andrews, School of Physics and Astronomy and the Biomedical Sciences Research Complex, St. Andrews, KY16 9SS UK

3. University of California Santa Barbara, Department of Physics, Santa Barbara, CA 93106

Hydration water is critical for protein structure, function, kinetics, and thermodynamics. We focus on studying the role and property of hydration water in the light-induced conformational changes of a photo-switchable protein, AsLOV2, whose photocycle is base-catalyzed.¹ However, the putative catalytic base has not been experimentally identified. Our results signify the credibility of water as the catalytic base. Using ODNP we find that, water dynamics surprisingly decrease on the surface of AsLOV2 across all sites examined upon light activation. Because the J-alpha helix is known to partially unfold upon illumination, the observation of decreased water dynamics was counterintuitive and gave rise to our hypothesis that structured water bound to AsLOV2 in the dark state is getting evicted upon light activation. To potentially observe the release of water from the protein surface upon illumination, we measured ¹⁷O solution NMR spectra. We successfully suppressed the bulk water signal and could identify the remaining water signal as bound water because its lineshape changed from 100% Lorentzian (bulk water) to 96% Gaussian.² Notably, we also observed an increase in the amplitude of a sharper ¹⁷O NMR resonance and change in lineshape (87% Gaussian) upon light activation of AsLOV2. Even though still preliminary, this is consistent with the water eviction hypothesis. The Lovett group performed high-pressure DEER at Q-band on the nitroxide-labeled-AsLOV2 at the sites 537 and 406, and successfully showed that compression of AsLOV2 (at 3kbar) induces the same partial unfolding as seen with light activation, which suggests that the underlying mechanism could very well be the eviction of structured water. Together our results emphasize the importance of water in the structure and function of AsLOV2, and potentially as the catalytic base.

We acknowledge financial support from NSF MCB-2025860 and UCOP through MRI-19-601107.

[1] M. Alexandre, et.al, Biochemistry 2007, 46, 11, 3129-313

[2] R. Zhang, et.al, JACS 2022, 144, 17, 7881-7888

EPR ORAL SESSION

Shiny Maity, University of California Santa Barbara, 570 Bolinas Way unit 102, Goleta, California, 93117, United States

Tel: 8054559613, E-mail: shinymaity@ucsb.edu

118 Estimation of Relaxation Times on the Coherent Pathways, $p = +1$ and $p = -1$, During Free Evolution on the SECSY Signal of an Electron-nuclear Spin-coupled System in a γ -irradiated Malonic Acid Single Crystal

Sushil K. Misra, Hamid Reza Salahi

Physics Department, Concordia University, 7420 Sherbrooke St. West, Montreal, Quebec H4B 1R6, Canada

The different relaxation rates, T_1 and T_2 , on the two coherent pathways, $p = +1$ and $p = -1$, respectively, during free evolution, on the SECSY (Spin Echo Correlation Spectroscopy) signal of the electron-nuclear spin-coupled system in a γ -irradiated malonic acid single crystal, are estimated by fitting to the intensities of the peaks in the Fourier transform of the observed SECSY signal by Lee, Patyal and Freed (J. Chem. Phys. 98, 3665 (1993)). It is found that the fitted relaxation rates, specifically, satisfactorily account for the difference in the intensities of the two main peaks in the Fourier transform of the observed SECSY signal. Full details of the calculations solving the Liouville von Neumann equation in Liouville space are presented.

EPR ORAL SESSION

Sushil K. Misra, Concordia University, 7420 Sherbrooke St. West, Montreal, Quebec, H4B 1R6, Canada

Tel: 15149440985, E-mail: sushil.misra@concordia.ca

119 14 T DNP and EPR of P1 Centers in Diamonds

Ilia Kaminker

School of Chemistry, Tel-Aviv University, Tel-Aviv Israel

Unlocking the full potential of Dynamic Nuclear Polarization (DNP) to enhance NMR sensitivity requires a deep understanding of the mechanisms mediating the electron-nuclear polarization transfer underlying DNP. To this end, it is essential to study electron spin dynamics under high fields typical of contemporary NMR experiments, but the required instrumentation for this is currently scarce. Recently, an efficient ^{13}C DNP using the P1 center, a ubiquitous paramagnetic defect in synthetic diamonds, was demonstrated at room temperature at 3.3 T by Shimon et al.¹ Interestingly, the DNP spectra revealed that multiple DNP mechanisms are simultaneously present and the hyperpolarization proceeds via very rich spin dynamics. Our recent experiments at 14 T, a field more characteristic to NMR measurements show that P1 center DNP is still very efficient. Interestingly, significant state mixing caused by the ^{14}N -e hyperfine coupling, which does not occur at lower fields, results in even more complex electron spin dynamics and DNP spectra. Previously, electron-electron double resonance (ELDOR) experiments were shown to be essential for the understanding of DNP mechanisms under static conditions.^{2,3} In this presentation, we describe our recently constructed 14 T DNP/EPR spectrometer and show our EPR, ELDOR, and DNP results at 14 T on high-pressure, high-temperature (HPHT) synthetic diamonds. We show that state mixing and the presence of exchange-coupled P1 centers strongly promote electron-electron spectral diffusion.

[1] Shimon, D. et al. Large Room Temperature Bulk DNP of ^{13}C via P1 Centers in Diamond. J. Phys. Chem. C 126, 17777–17787 (2022).

[2] Hovav, Y. et al. Effects of the electron polarization on dynamic nuclear polarization in solids. Phys Chem Chem Phys 17, 6053–6065 (2015).

[3] Shimon, D. & Kaminker, I. A transition from solid effect to indirect cross effect with broadband microwave irradiation. Phys. Chem. Chem. Phys. 24, 7311–7322 (2022).

EPR ORAL SESSION

Ilia Kaminker, Tel-Aviv University, Tel-Aviv University, Tel-Aviv, HaMerkaz, 6997801, Israel

E-mail: iliakam@tauex.tau.ac.il

120 Diamond NVs as a Playground for Quantum Cavity-spin Dynamics at Ambient Conditions

Aharon Blank

Schulich Faculty of Chemistry, Technion - Israel Institute of Technology, Haifa, Israel

Magnetic resonance (MR) can be used as a testbed for observing, demonstrating and studying fundamental concepts of quantum cavity interaction with a two-level system. Such experiments are mostly carried out at low cryogenic temperatures with spin systems that are highly polarized, embedded in a very high-quality (Q-factor) superconducting cavity. The photons in the cavity can excite the spin system, which in turn, can also excite the cavity back, revealing a plethora of non-linear quantum phenomena, such as splitting the resonance frequency of the cavity (strong coupling), multiple echo formation and superradiance. In this work, we show that using a unique tailor-made low Q cavity, in conjunction with diamond crystals having large concentration of nitrogen vacancy (NV) centers, such non-linear quantum phenomena can be observed even at ambient conditions. For example, we present measurements and theoretical analysis of multiple echoes appearing after a simple two Hahn pulse sequence. We also discuss the possibility of demonstrating superadiance with such system. Finally, we show that our experimental system can also be used to cool the electromagnetic mode of the resonator to a temperature well below its ambient temperature, with potential implications for microwave-related quantum circuits, such as superconducting qubits.

EPR ORAL SESSION

Aharon Blank, Technion, Chemistry, Haifa, Hefa, 3200003, Israel
Tel: 048293679, E-mail: ab359@technion.ac.il

121 Maser Threshold Characterization by Resonator Q-Factor Tuning

Christoph W. Zollitsch,^{1,2,3} Jonathan D. Breeze,¹ Christopher W. M. Kay^{2,3}

1. Department of Physics & Astronomy, University College London, Gower Street, WC1E 6BT, UK
2. London Centre for Nanotechnology, University College London, 17-19 Gordon Street, WCH1 0AH, UK
3. Department of Chemistry, Saarland University, Saarbrücken, 66123, Germany

The concepts for microwave amplification by stimulated emission of radiation (maser) closely followed by the optical analogue, the laser, were developed in the 1950s. Whereas the laser is now a ubiquitous technology, used in fundamental science, industry and everyday life, applications for the maser remain highly specialized e.g., for deep-space communication and astronomy. Although the excellent low-noise microwave amplification properties of the maser made it an attractive candidate for a broad range of applications, the original maser system required cryogenic temperatures and/or high vacuum environments; both are major barriers for widespread applications. Thus, the recent realization of a continuous-wave room-temperature maser, using NV⁻ centers in diamond, reinvigorated the maser as an intriguing platform for microwave research and development¹. Building on this work, we designed and constructed an optimized setup in order to characterize the operating space of a maser using NV⁻ centers. Here we focus on the interplay of two key parameters for continuous emission of microwave photons: the quality factor of the microwave resonator and the degree of spin-level-inversion. We characterized the performance of the maser as a function of these two parameters, identified the parameter space of operation and could, thereby, highlight the requirements for maximal continuous microwave emission².

[1] Breeze et al. Nature, **2017**, 555, 493

[2] Zollitsch et al. arXiv:2302.10811

EPR ORAL SESSION

Chris W. M. Kay, University of Saarland, Campus B22, Saarbrücken, Saarland, 66123, Germany
E-mail: christopher.kay@uni-saarland.de

122 Investigation of Intrinsic Linewidths in NV-detected ¹³C NMR at 4.2 Tesla

Yuhang Ren¹, Cooper Selco¹, Dylan Kawashiri¹, Michael Coumans², Benjamin Fortman², Louis S. Bouchard³, Karoly Holczner⁴ and Susumu Takahashi.^{1,2}

1. Department of Physics & Astronomy, University of Southern California
2. Department of Chemistry, University of Southern California
3. Department of Chemistry & Biochemistry, University of California
4. Department of Physics & Astronomy, University of California

The nitrogen-vacancy (NV) center in diamond has enabled widespread study of nanoscale NMR and electron spin resonance (ESR) at low magnetic fields. However, low-field NV-detected NMR is limited in its spectral resolution, usually on the orders of 10,000 ppm. This prevents study of complex molecular structure and nanoscale dynamics. In high field, we achieve a resolution of 50 ppm in our study, potentially differentiating carbon single and double bond on a molecular level. E.g., it is essential in understanding cholesterol and ergosterol biosynthesis with reductases like DHCR7, which will reduce carbon double bonds. Furthermore, there have been few studies of NV-detected NMR at high fields due to technical challenges. Optically detected magnetic resonance (ODMR) at high field produces significantly smaller fluorescence (FL) signal and microwave engineering at high field is under developed. Traditional pulse sequence like ESEEM is not applicable in high field and EDNMR is not capable of revealing small intrinsic linewidth. In this work, we present an NV-detected NMR technique suitable for applications at high magnetic field. We perform ¹³C NV-detected NMR at the NV Larmor frequency of 115 GHz and magnetic field of 4.2 Tesla. We analyze the contributions to the NMR linewidths for two diamond samples and show that the method can capture the intrinsic NMR spectrum. This work demonstrates a clear path to high resolution NV-detected NMR at high magnetic fields.

EPR ORAL SESSION

Yuhang Ren, University of Southern California, 3551 Trousdale Pkwy, Los Angeles, California, 90007, United States
E-mail: yuhangre@usc.edu

123 TBA

124 TBA

- 125 Quintet and Triplet Dynamics in Intramolecular Singlet Fission of Diphenylhexatriene Oligomers**
Jeannine Grüne¹, Oliver Milington^{1,2}, Steph Montanaro², Simon Dowland¹, Neil Greenham¹, Hugo Bronstein^{1,2}, Akshay Rao¹
1. Cavendish Laboratory, University of Cambridge, JJ Thomson Avenue, Cambridge, UK
2. Department of Chemistry, University of Cambridge, Lensfield Rd, Cambridge, UK

Singlet fission (SF) is a key concept for improving the efficiency of solar cells by enabling a multiplication of photoexcited states. The principle is based on a photoexcited singlet exciton rapidly decaying into spin-correlated triplet pairs that dissociate into free triplets. We combine the complementary techniques of optical spectroscopy with electron paramagnetic resonance (EPR) to monitor the intermediate states with different spin multiplicities. EPR spectroscopy thereby allows to identify the involvement of exchange-coupled triplet pairs with quintet character ($S=2$), which dissociate into weakly coupled triplet pairs ($S=1$) via SF. We focus on new concepts of intramolecular singlet fission (iSF) based on units of the SF-active chromophore diphenylhexatriene (DPH). We found that upon fast iSF to generate strongly exchange-coupled triplet pairs, the efficiency of dissociation into free triplets strongly depends on the overall geometry and the number of molecular units. The characterization of various oligomers allows the study of the involved quintet and triplet dynamics to find a general recipe for efficient iSF materials.

EPR ORAL SESSION

Jeannine Grüne, University of Cambridge, JJ Thomson Ave, Cambridge, England, CB3 0HE, United Kingdom
E-mail: jg2082@cam.ac.uk

- 126 Transient EPR and Transient Absorption Spectroscopy of Pentacene-Nitroxide Derivatives**
Trent A. McHenry¹, Philip Weiss¹, Thiago Rubio¹, Karthikeyan Ganesan², Pete Budden³, Matthew Sfeir^{3,4}, Olivier Ouari² and Claudia E. Avalos¹.
1. Department of Chemistry, New York University, New York, New York 10003, USA
2. Institut de Chimie Radicalaire, CNRS/Aix Marseille Université, Marseille 13013, France
3. Photonics Initiative, Advanced Science Research Center, City University of New York, New York, New York 10031, USA
4. Department of Physics, Graduate Center, City University of New York, New York, NY 10016, USA

The ability to generate large electron spin polarization has applications in magnetometry, quantum information science and magnetic resonance sensitivity enhancement. Chromophore-radical (C-R) dyads are a promising class of molecules for these applications since their optical and spin properties can be tuned via judicious choices of chromophore, linker and radical moieties. Recently, there has been increased interest in developing optically polarizable chromophore-biradical derivatives for optically pumped magic angle spinning dynamic nuclear polarization (MAS-DNP) which could have advantages over standard MAS-DNP methods, including larger signal enhancement and lower cost. Pentacene-radical derivatives have been shown to produce ground state electron spin polarization on a tethered radical via an enhanced intersystem crossing (EISC) pathway. EISC is mediated by the electron exchange coupling, J_{ex} , which depends on the wavefunction overlap of the excited chromophore and radical and energy difference between the excited chromophore's triplet and singlet states. Here, we investigate optical and spin properties of mono and bi-radical nitroxides tethered to pentacene via a shortened alkyne linker that increases J_{ex} between the radical and triplet pentacene. We measure modest MAS-DNP enhancements using the unpolarized pentacene bi-nitroxide and use pulsed EPR to measure the ground state spin lifetime and correlation parameters. Transient absorption results indicate that a pentacene triplet is not formed in either pentacene-radical system. Instead, following decay of the pentacene singlet, a residual long-lived excited state is observed that lacks signatures of localized pentacene character. Transient EPR measurements on pentacene-nitroxide derivatives indicate formation of ground state spin polarization on nitroxide pentacene radicals after optical excitation, however no evidence of quartet state formation was observed. Excited state calculations on pentacene-nitroxide derivatives were performed to identify extent of overlap between excited pentacene and nitroxide orbitals. These studies aim to improve our understanding of the factors leading to ground-state spin polarization in chromophore-radical derivatives.

EPR ORAL SESSION

Trent McHenry, New York University Chemistry Department, 88 Eldert Street Apt #2, Brooklyn, New York, 11207, United States
Tel: 9134242159, E-mail: tam9987@nyu.edu

- 127 Developing Optically Addressable Molecular Qubits for Quantum Technologies**
L.R. Weiss^{1,2}
1. University of Chicago, Pritzker School of Molecular Engineering, Chicago, IL, 60637, USA
2. Tohoku University, WPI-Advanced Institute for Materials Research, Sendai, 980-8577, Japan

Molecular systems provide a promising platform for bottom-up design of quantum properties with potential future applications in quantum sensing, networked quantum communication, and information technologies. Recently,

organometallic molecules have been used to demonstrate coherent microwave control of optically addressable, ground-state molecular qubits¹. Understanding how to design molecular systems with desired spin and optical properties for this class of systems is a critical step toward application-tailored qubit design^{2,3}. In this talk, we discuss recent progress in the development of molecular qubits with robust spin-optical interfaces, opening avenues for future operation of synthetic qubits in noisy environments.

[1] Bayliss, S. L., et al. "Optically addressable molecular spins for quantum information processing." *Science* 370.6522 (2020): 1309-1312.

[2] Laorenza, Daniel W., et al. "Tunable Cr⁴⁺ molecular color centers." *Journal of the American Chemical Society* 143.50 (2021): 21350-21363.

[3] Bayliss, S. L., et al. "Enhancing Spin Coherence in Optically Addressable Molecular Qubits through Host-Matrix Control." *Physical Review X* 12.3 (2022): 031028.

EPR ORAL SESSION

Leah R Weiss, University of Chicago, 5640 S. Ellis Avenue, Chicago, Illinois, 60637, United States

E-mail: lrweiss@uchicago.edu

128 High-Field Pulsed EPR for Spin Population Transfer in a Gd³⁺ Molecular Crystal

M.V.H. Subramanya,^{1,2} E. Salerno,¹ M. Gakiya,³ J. Marbey,^{1,2,4} K. Kundu,¹ M. Shatruk,³ and S. Hill.^{1,2}

1. National High Magnetic Field Laboratory, Florida State University, Tallahassee, FL 32310

2. Department of Physics, Florida State University, Tallahassee, FL 32306

3. Department of Chemistry & Biochemistry, Florida State University, Tallahassee, FL 32306

4. Laboratory of Physical Sciences, University of Maryland, College Park, MD 20740

Gd³⁺ is a spin $S = 7/2$ ion that has a half-filled $4f^7$ electron occupancy, with no first-order orbital angular momentum. As a result, its eight spin levels are minimally mixed and can typically be considered pure, exhibiting very weak zero-field splitting. For these reasons, the spin states of a Gd³⁺ ion can encode $N = 3$ addressable qubits (a $d = 2^N = 8$ level qudit). Electron paramagnetic resonance (EPR) permits the coherent manipulation of these spin states through fully allowed $\Delta m_S = \pm 1$ transitions facilitated by resonant microwave pulses. However, the Pulsed EPR spectrometer must meet several key requirements, including: (1) sufficient microwave power to achieve nanosecond time resolution; (2) broad excitation bandwidth and arbitrary waveform shaping in order to rapidly address spectrally separated spin transitions; and (3) high-sensitivity for detection of small samples with low spin concentrations. The quasi-optical 94 GHz HiPER spectrometer¹ at the National High Magnetic Field Laboratory satisfies all these requirements and additionally allows for in situ crystal rotation. We demonstrate dynamic spin population transfer within the ⁸S_{7/2} ground manifold of a molecular Gd³⁺ complex diluted into an isostructural non-magnetic Y³⁺ host crystal, paving the way towards implementation of simple quantum logic operations within a $d = 8$ molecular spin qudit. Also, we utilize an adiabatic frequency-swept pulse to initialize a spin qubit encoded within the $m_S = \pm 1/2$ spin states of a Gd³⁺ ion.

This work was supported by the DOE (DE-SC0020260), the NSF (DMR-1644779) and the State of Florida.

[1] Subramanya et al., *Appl. Magn. Reson.*, 2023, 54, 165–181.

EPR ORAL SESSION

Manoj V. H. Subramanya, Dept. of Physics, Florida State University, 77 Chieftan Way, Tallahassee, Florida, 32306, United States

E-mail: mh17e@fsu.edu

129 ESR Characterization of Zero-Field Clock Transitions in Silica-Glass Defects

Brendan C. Sheehan,^{1,2} Guanchu Chen,^{1,2} Jonathan R. Friedman.¹

1. Amherst College, Department of Physics & Astronomy, Amherst, MA 01002-5000

2. University of Massachusetts Amherst, Amherst, MA 01003-9305

Clock transitions (CTs) in nanomagnets are potentially useful qubit platforms due to their ability to suppress the decohering effects of dipolar fluctuations to first order and yield enhanced coherence times T_2 .^{1,2} Although not a molecular nanomagnet, certain structural glasses have shown a similar CT effect at zero magnetic field. In particular, borosilicate glass, a structural SiO₂-based glass featuring substitutional boron defects, has coherence times up to 5 μ s at the clock transition. T_2 can be further extended up to 25 μ s at the clock transition via the use of the CPMG pulse sequence. We present results on the CT in this system and investigate its materials origin. We do not observe a CT in other, related materials, including pure B₂O₃, fused silica and quartz (amorphous and crystalline SiO₂, respectively), and soda-lime glass (an SiO₂-based glass with various interstitial defects). However, we find that aluminosilicate glass presents exhibits CT behavior, suggesting the presence of electron acceptor atoms as structural defects gives rise to an integer-spin system that is necessary for a zero-field avoided crossing. We investigate the hypothesis that the observed

CTs are due to a spin-1 boron-vacancy center within the borosilicate glass, and, similarly, an aluminum-vacancy center in the aluminosilicate glass.

Supported by RCSA Cottrell SEED Award #27849.

- [1] M. Shiddiq, et. al., Nature **531**, 348–351 (2016).
- [2] C. Collett, et. al., Magnetochemistry **5**, 1 (2019).

EPR ORAL SESSION

Brendan Sheehan, Amherst College Physics Department, University of Massachusetts Amherst, 25 East Drive, Amherst, Massachusetts, 01002-5000, United States
Tel: 9148865750, E-mail: bcsheehan@umass.edu

130 Spin–Electric Coupling in a Copper(II)-Based Spin Triangle Revealed by Electric-Field-Modulated Electron Paramagnetic Resonance Spectroscopy

Maria Fittipaldi¹, Alberto Cini¹, Mauro Perfetti², Benjamin Kintzel³, Michael Böhme³, Winfried Plass³, and Roberta Sessoli²

1. Department of Physics and Astronomy and INSTM Research Unit, University of Florence, via Sansone 1, I-50019 Sesto Fiorentino, Italy

2. Department of Chemistry ‘Ugo Schiff’ and INSTM Research Unit, University of Florence, via della lastruccia 3-13, I-50019 Sesto Fiorentino, Italy

3. Institute of Inorganic and Analytical Chemistry, Friedrich Schiller University Jena, Humboldt str. 8, 07743 Jena, Germany

Magnetolectrics (ME), i.e. materials that exhibit coupling between magnetic and electric degrees of freedom, not only offer a rich playground for studying the fundamental physics of spin-charge coupling^[1] but they can also open the road to develop new device concepts^[2], disclosing unforeseen technological scenario with possible positive achievement for human life.

The possibility to operate on magnetic materials through the application of electric rather than magnetic fields - promising faster, more space confined and energy efficient circuits - continues to spur the investigation of ME effects^[3]. Symmetry considerations, in particular the lack of an inversion centre, characterize linear ME effect. In addition, spin-orbit coupling is generally considered necessary to make a spin system sensitive to a charge distribution. However, a ME effect not relying on spin-orbit coupling is appealing for spin-based quantum technologies. We have very recently reported the detection of a ME effect that we have attributed to an electric field modulation of the magnetic exchange interaction without atomic displacement [4]. The effect is visible in electron paramagnetic resonance (EPR) absorption of molecular helices under electric field modulation (EFM-EPR) and confirmed by specific symmetry properties and spectral simulation.

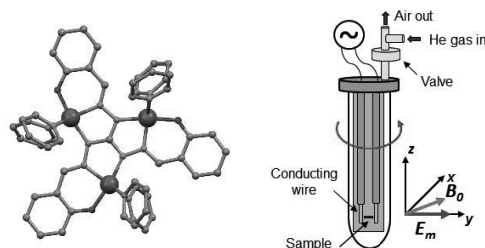

Fig. 1 Left: the molecular structure of the spin-frustrated Cu₃, with a total ground state S=1/2. Right: schematic view of the modified version of the sample holder used for the EFM-EPR measurements. The electric field (E_m) is obtained by applying an alternating voltage $V = V_0 \cos(\omega t)$, with $V_0 = 170$ V over a distance of 1.5 mm, and $\omega = 2\pi \times 30$ kHz.

After this report, an improvement in the experimental setup made possible the observation of a ME effect in a single-crystal of a frustrated Cu₃ triangle (Fig. 1). The orientation dependence of the effect was recorded and fully analysed by means of a phenomenological model, as well as by extensive computational studies. Therefore, the magnitude and the anisotropy of the variations of Hamiltonian tensors induced by the electric field have been revealed: representing a significant step forward for the design of new molecular-based systems with efficient spin-electric effects.

- [1] J. Liu et al., Sci. Adv., **2021**, 7(10), eabf8103.
- [2] Multiferroics march on, Nat. Mater., **2019**, 18, 187.
- [3] N. A. Spaldin, and M. Fiebig, Science, **2005**, 309, 391.

EPR ORAL SESSION

Maria Fittipaldi, Department of Physics and Astronomy - University of Florence, Via Sansone 1, Sesto Fiorentino, Toscana, 50019, Italy
Tel: 0039 0554572263, E-mail: maria.fittipaldi@unifi.it

131 In situ EPR Investigation of Oxygen Vacancies Induced Ferrimagnetism in Metal Oxide Catalysts

Mikhail Agrachev,¹ Thaylan Pinheiro Araújo,² Cecilia Mondelli,² Tangsheng Zou,² Konstantin M. Engel,² Robert N. Grass,² Wendelin J. Stark,² Simon Verstraeten,² Patrik O. Willi,² Robert N. Grass,² Olga V. Safonova,³ Jordi Morales-Vidal,^{4,5} Núria López,⁴ Sharon Mitchell,² Javier Pérez-Ramírez,² Gunnar Jeschke.¹

1. ETH Zurich, Laboratory of Physical Chemistry, Department of Chemistry and Applied Biosciences, Vladimir-Prelog-Weg 2, Zurich, 8093, Switzerland
2. ETH Zurich, Institute of Chemical and Bioengineering, Department of Chemistry and Applied Biosciences, Vladimir-Prelog-Weg 1, Zurich, 8093, Switzerland
3. Paul Scherrer Institute, Forschungsstrasse 111, Villigen, 5232, Switzerland
4. Institute of Chemical Research of Catalonia (ICIQ), The Barcelona Institute of Science and Technology, Av. Països Catalans 16, Tarragona, 43007, Spain
5. Universitat Rovira i Virgili, Av. Catalunya 35, Tarragona, 43002, Spain

Metal oxides are widely used as catalysts for CO₂ to MeOH conversion. It is believed that the active sites for this reaction consist in oxygen vacancies, which can coordinate CO₂ molecules and promote the reaction with hydrogen adsorbed on the oxide surface. However, the reaction mechanism is still unclear, as the oxygen vacancies are hard to detect experimentally. Here we address this problem with EPR, focusing on In₂O₃ and ZnO-based catalysts supported on ZrO₂ and doped with different metal promoters, which further improve the catalytic performance.^{1,2}

It is known that oxygen vacancies can easily trap unpaired electrons, thus becoming paramagnetic and therefore EPR-active. Isolated paramagnetic vacancies give rise to sharp, almost isotropic signals with g factors near to g_e. However, as we show here, as the density of vacancies increases, extremely broad signals appear, with features typical for ferro- and antiferromagnets.¹ We attribute these signals to exchange-coupled vacancy-bound magnetic polarons. Exchange couplings can be either direct or mediated by paramagnetic metal ions, leading to a competition between ferro- and antiferromagnetism. We propose a quantitative approach for the spectral analysis to describe this behaviour and elucidate the nature and the dynamics of oxygen vacancies.

These signals, as well as the signals of other species involved in the reaction and the conductivity, related to the oxygen vacancies formation, were monitored in situ with a home-build resonator and setup working at high temperatures (300°C) and high pressures (10 bar), thus closely reproducing the optimal working conditions of the catalyst.

The importance of these findings is related both to metal oxide catalysis and to the fundamental understanding of the magnetic properties of metal oxides and their EPR spectra.

[1] Pinheiro Araújo, T. et al., *Nat. Commun.*, **2022**, 13, 5610.

[2] Pinheiro Araújo, T. et al., *Adv. Energy Mater.*, **2023**, 13, 2204122.

EPR ORAL SESSION

Mikhail Agrachev, ETH Zurich, Vladimir Prelog Weg 2, HCI F 223, Zurich, Zurich, 8093, Switzerland
E-mail: magrachev@ethz.ch

132 EPR Study of Charge Transfer Co-crystals of Perylene/TCNQ, Anthracene/TCNQ and DBTTF/F4TCNQ

Tamar Ben Avraham,¹ Enrico Da Como,² Claudio Fontanes,³ Linda Shimon,¹ Raanan Carmieli¹

1. Department of Chemical and Biological Physics, Weizmann Institute of Science, Rehovot 76100 Israel
2. Centre for Photonics and Photonic Materials (CPPM) and Department of Physics, University of Bath, BA2 7AY, United Kingdom
3. DIF, University of Modena and Reggio Emilia, via Vivarelli 10, 41125 Modena, Italy

Organic charge-transfer (CT) co-crystals exhibit unique electronic and magnetic properties depending on their molecular packing structures and aggregate states which exhibit a variety of novel properties through multicomponent synergistic and collective effects. Here we present the EPR study of three type types of co-crystals: perylene/ tetracyanoquinodimethane (TCNQ, anthracene/TCNQ and the charge transfer co-crystal formed by dibenzotetrathiafulvalene (DBTTF) together with 2, 3, 5, 6-tetrafluoro-7, 7, 8, 8-tetracyanoquinodimethane (F4TCNQ). While the first two form mixed stacking structure with localized radicals the third one presents a long-range ordered supramolecular structure of segregated stacks, with a unitary degree of charge transfer. Thus, the crystal structure is composed of dimerized radical molecules with unpaired electrons. EPR temperature studies of polycrystalline sample revealed that oxidation reduction reaction doesn't occur between every two neighboring molecules but upon charge transfer the electron migrate through the stack from 18.6 Å at 5 K up to 19.42 Å at 300 K. Between 100 to 150 K we

observed the shortest distances of 17-16.87 Å suggesting a glass transition behavior in this temperature range.

EPR ORAL SESSION

Raanan Carmieli, Weizmann Institute of Science, Hertzl st, Rehovot, HaMerkaz, 76100, Israel
Tel: +97289343410, E-mail: raanan.carmieli@weizmann.ac.il

133 Clock Transition and ESEEM in the Cr₇Mn Molecular Nanomagnet

Guanchu Chen,^{1,2} Brendan Sheehan,^{1,2} Grigore Timco,³ Jillian Denhardt,⁴ Kevin Kittilstved,⁴ Richard Winpenny,³ and Jonathan R. Friedman.^{1,2}

1. Amherst College, Department of Physics and Astronomy, Amherst, MA 01002-5000
2. University of Massachusetts Amherst, Department of Physics, Amherst, MA 01003-9337
3. University of Manchester, Department of Chemistry, Manchester, M13 9PL, UK
4. University of Massachusetts Amherst, Department of Chemistry, Amherst, MA 01003-9305

The Cr₇Mn molecular nanomagnet, a heterometallic ring, is a spin-1 system. Its two lowest spin states exhibit an avoided level crossing at zero field, giving rise to a “clock transition.” At a clock transition, the transition frequency is immune from the decohering effects of small field fluctuations, resulting in an extended coherence time T₂.¹ To further enhance T₂, we utilize dynamical decoupling techniques such as the CPMG pulse sequence. Additionally, the Cr₇Mn nanomagnet exhibits a significant Electron Spin Echo Envelope Modulation (ESEEM) signal. The signal magnitude implies the existence of alternative mechanisms for maintaining coherence beyond the clock transition regime, which involves coupling to nuclear spins. By employing the CPMG sequence, we measured the corresponding T₂ at different fields and found it comparable to that at the clock transition. Numerical calculations allow us to quantitatively model the observed ESEEM oscillations in Cr₇Mn. Such simulations provide a window into understanding the primary decoherence mechanisms in this system, and provide some insights into schemes to preserve coherence.

Supported by NSF grant no. DMR-1708692 and DMR-2207624.

[1] C. A. Collett et al., *Magnetochemistry* **2019**, 5, 4.

EPR ORAL SESSION

Guanchu Chen, Amherst College, 25 East Drive, Amherst, Massachusetts, 01002, United States
E-mail: guanchuchen@umass.edu

135 Dinuclear Cr(III) Complexes with Uncommon Bridges and the Importance of the Biquadratic Exchange Interactions

Andrew Ozarowski,¹ Eranga H. Gamage,^{2,3} Raquel A. Ribeiro,^{3,4} Colin P. Harmer,^{2,4} Paul C. Canfield^{3,4} and Kirill Kovnir^{2,4}

1. National High Magnetic Field Laboratory, Florida State University, Tallahassee, FL 32310 USA
2. Department of Chemistry, Iowa State University, Ames, IA 50011 USA
3. Department of Physics and Astronomy, Iowa State University, Ames, IA 50011 USA
4. Ames Laboratory, U.S. Department of Energy, Ames IA 50011 USA

The possibility of utilizing dimeric selenium-bridged transition metal complexes as catalysts for organic reactions has been studied over the past few decades. Chemistry of the linear Cr₂Se and butterfly Cr₂Se₂ complexes has been explored. In this work, ethylenediamine complexes in which two Cr(III) ions are bridged by either double monoatomic Se or S, or single diatomic Se-Se bridges were studied using a variety of physical methods including high-resolution synchrotron PXRD, magnetic susceptibility measurements and High-Field, High-Frequency Electron Paramagnetic Resonance (HFEP²R).¹ The magnetic studies revealed that the Cr-Cr exchange interaction has antiferromagnetic character in the Cr₂Se₂ and Cr₂S₂ systems like Cr₂Se₂(en)₄Br₂, while it is ferromagnetic in the (en)₂Se₃CrSe-Se-CrSe₃(en)₂ complex. Inclusion of the biquadratic exchange term $j(S_1S_2)_2$, in addition to the HDVV Hamiltonian $J\mathbf{S}_1\mathbf{S}_2$ was needed to reproduce the experimental magnetic data. Well resolved HFEP²R signals coming from the coupled triplet spin state (S=1) were observed for the three antiferromagnetic complexes. Determination of the zero-field splitting parameters in the coupled S=1 state allowed to estimate the magnitude of the zero-field splitting parameter D on the individual Cr³⁺ ions. “Broken symmetry” Density Functional Theory (DFT) calculation were performed to get insight into the exchange interactions. Reasonable agreement between the experimental and theoretical exchange integrals J was obtained.

[1] E. H. Gamage, et al., *Inorg. Chem.*, **2022**, 61, 6160-6174

EPR ORAL SESSION

Andrew Ozarowski, NHMFL, 1800 E. Paul Dirac Drive, Tallahassee, Florida, 32310, United States
Tel: 8506445996, E-mail: ozarowsk@magnet.fsu.edu

136 Multifrequency Electrically Detected Magnetic Resonance Setup Based on a sub-THz FraScan SpectrometerArtur Solodovnyk,^{1,2} Dariya Savchenko,^{3,4} Oleksii Laguta,² and Petr Neugebauer.²

1. The Pennsylvania State University, Department of Engineering Science and Mechanics, University Park, PA 16802, United States

2. Central European Institute of Technology, Brno University of Technology, Brno 61200, Czech Republic

3. Institute of Physics of the Czech Academy of Sciences, Prague 18221, Czech Republic

4. National Technical University of Ukraine “Igor Sikorsky Kyiv Polytechnic Institute”, Kyiv 03056, Ukraine

Electrically detected magnetic resonance (EDMR) is a powerful spectroscopic technique for the investigation of semiconductor materials and devices. Compared to other methods based on magnetic resonance, it is distinguished by high spin sensitivity and the ability to study spin-dependent transport processes, which are important for semiconductor device development. The urge to access more accurate high-resolution information to broaden the method's research possibilities led us to high frequency and high magnetic field EDMR implementation. We present an EDMR setup based on a novel THz FraScan spectrometer, which operates at sweepable frequencies of 80 GHz – 1.1 THz and magnetic fields up to 16 T. We will demonstrate the hardware design, the detection scheme, and the 85 – 328.84 GHz EDMR measurements on highly nitrogen-doped 15R SiC monocrystals.¹⁻³ In addition, the results show qualitative advantages of using frequency domain EDMR (FD EDMR) over conventional magnetic field sweeps in terms of much higher SNR and the possibility of recording a frequency-field map (FFM EDMR).

[1] A. Solodovnyk, Ph.D. dissertation, Central European Institute of Technology BUT, **2022**.

[2] A. Solodovnyk, O. Laguta, A. Prokhorov, M. Segantini, B. Naydenov, P. Neugebauer, S. Greulich-Weber, E. Kalabukhova, and D. Savchenko, *Phys. Rev. B*, **2023**, 107, 155202.

[3] A. Solodovnyk, D. Savchenko, O. Laguta, and P. Neugebauer, *IEEE Trans. Instrum. Meas.* (to be published).

EPR ORAL SESSION

Artur Solodovnyk, 212 Earth and Engineering Sciences, State College, Pennsylvania, 16802, United States

E-mail: abs7141@psu.edu

137 Patches and Pockets of Weird Water: New Frontiers for ODNPAlec A Beaton, Farhana Syed, Warren Kincaid, Alexandria Guinness, John M Franck
Syracuse University, Syracuse, NY

Overhauser Dynamic Nuclear Polarization (ODNP) utilizes electron spins to enhance and isolate the properties of small pockets or patches of water in the hydration layer of large macromolecules and of aggregate structures. We have specifically utilized ODNP to observe the quenching of translational motion inside small pockets formed by surfactants (in reverse micelles), to observe how surfactant or lipid packing affects the mobility of water near transmembrane proteins, and to begin to unlock the potential of energy stored in the hydration layer by characterizing the hydration layer of a simple signaling protein.

Already, ODNP achieves the surprising capability of picking out the behavior of a nanoscale volume of water against an overwhelming majority of bulk water. For this, it relies on (1) the ability of electron spins to transfer their >600 fold polarization to the proton spins, (2) the ability to rapidly replenish the depleted signal through fast electron spin relaxation, and (3) a reliance on rapid exchange with bulk water that replenishes “encoded” water molecules. To advance the methodology, it must become capable of quantifying relatively small changes in nuclear spin (hyper)polarization: whether that means quantifying signal coming from small isolated pockets of water, or that means analyzing the result of a small depletion of Boltzmann polarization arising from relatively few spin labels or from spin labels with relatively inaccessible water. This is especially true when seeking retrieval of the relaxation and cross-relaxation rates needed to understand the local molecular dynamics^{1,2}.

Here, we will focus in part on the phenomenon of “dynamic resonance” where ODNP cross-relaxation rates rise to a maximum when the correlation time matches the characteristic frequency of the transition of interest. This phenomenon unambiguously identifies the correlation time of the water motion, and initial temperature-dependent studies agree well with existing models for small spin label systems.

[1] Franck JM, Han S. “Overhauser Dynamic Nuclear Polarization for the Study of Hydration Dynamics, Explained.” In: Wand AJ, editor. *Biol NMR part B: Methods Enzymol Academic Press*; 2019. p. 131–175. doi:10.1016/bs.mie.2018.09.024.

[2] Beaton AA, Guinness A, Franck JM. “A modernized view of coherence pathways applied to magnetic resonance experiments in unstable, inhomogeneous fields.” *J Chem Phys.* 2022 Nov;157(17):174204. doi:10.1063/5.0105388.

EPR ORAL SESSION

John M Franck, Syracuse University, 111 College Pl, Syracuse, New York, 13211, United States

Tel: 3154433171, E-mail: jmfranck@syr.edu

138 **Improving Sensitivity of Distance Measurements at Nanomolar Protein Concentrations using Double Quantum Coherence**

Alysia Mandato,¹ Zikri Hasanbasri,¹ and Sunil Saxena¹

1. University of Pittsburgh, Department of Chemistry, Pittsburgh, PA 15213

Recently, there have been remarkable improvements in pulsed EPR sensitivity. Solvent and cryoprotectant deuteration have prolonged phase memory times of samples, cryogenic amplifiers have decreased measurement times, and spectrometers with low-noise microwave amplifiers have resulted in relaxation measurements of only 10^7 spins.¹⁻³ These achievements are paving the way for a broader applicability of EPR in measuring biological distance constraints, for instance, at physiological concentrations and for more complex systems. Nonetheless, there remains a need for rapid and reliable methods of measuring distances between spins at nanomolar concentrations. Currently, nanomolar distance measurements with the commonly used nitroxide spin label take multiple days using double electron-electron resonance (DEER) spectroscopy. In this work, we demonstrate the sensitivity of double quantum coherence (DQC) experiments at Q-band frequencies. We achieve highly sensitive distance measurements at nanomolar protein concentrations with DQC in significantly less time as compared to DEER. Additionally, we observe improved signal modulations, which open up new applications for distance measurements. We anticipate nanomolar concentration measurements will lead to further advancements in sensitivity, especially in in-cell contexts.

Supported by NSF BSF MCB-2006154.

[1] Casto et al., Phys. Chem. Lett., 2021, 12, 4681.

[2] Kalendra et al., Magn. Reson., 2023, 346, 107356.

[3] Isaev et al., Magn. Reson. Open, 2023, 14-15, 100092.

[4] Hasanbasri, et al., Chem. Chem. Phys., 2023.

EPR ORAL SESSION

Alysia Mandato, University of Pittsburgh, 219 Parkman Ave, Pittsburgh, Pennsylvania, 15213, United States

E-mail: atm75@pitt.edu

139 **Can Magnetic Resonance Force Microscopy Detect and Image Individual Nitroxide Spins?**

John A. Marohn,¹ Michael C. Boucher,¹ Peter Sun,¹ Russell W. Burgett,¹ Corinne E. Isaac,¹ Pamela T. Nasr,¹ Lee E. Harrell,² Roger F. Loring,¹ and Robert D. McMichael³

1. Cornell University, Ithaca, NY 14850

2. U.S Military Academy, West Point, NY 10996

3. National Institute of Standards and Technology, Gaithersburg, MD 20899

If we could acquire the three-dimensional coordinates of nitroxide electron spins affixed to individual copies of proteins or nucleic acids, then we would have a powerful new approach for determining the assembly state of a wide range of interesting biological complexes. Magnetic resonance force microscopy has detected and imaged electron spin resonance from single dangling bonds in quartz. Can it likewise be used to detect and image individual nitroxide spins? We have developed cantilevers having cobalt nanorod tips producing 5 mT/nm of magnetic field gradient. The estimated single-electron force is 45 aN, well above our cantilever noise floor of 5 aN (in 1 Hz) at 4.2 kelvin, suggesting that detecting single electrons in seconds of signal averaging time is feasible. We can routinely observe electron spin resonance from millions of molecules using micron-scale tips, and the observed lineshape agrees well with simulations. Yet when we replace the micron-scale tips with nanorod tips having larger gradients, the observed signal is 450 times smaller than expected and the observed lineshape agrees poorly with simulations. Why are we losing signal? Metal coating the sample reduces surface noise but, we show, damages the sample. A new, gentle, laminated-sample protocol increases signal 15-fold while reducing surface noise^[1]. Another source of signal loss is the breakdown of saturation due to large resonance offsets caused by cantilever motion^[2]. T1 reduction from stochastic magnetic field fluctuations is another concern; this is a common problem in quantum computing too. We report estimates of T1 loss from thermal conductivity fluctuations and thermomagnetic fluctuations obtained using a combination of theory, numerical calculations, and non-contact friction measurements.

Supported by NIH R01GM143556.

[1] Boucher, Marohn, et al. ACS Nano (2022) 17(2): 1153.

[2] Boucher, Harrell, Marohn, submitted (2023).

EPR ORAL SESSION

John A Marohn, Cornell University, 150 Baker Laboratory, Dept. of Chemistry and Chemical Biology, Ithaca, New York, 14853-1301, United States

Tel: 607-255-2004, E-mail: jam99@cornell.edu

140 **Demonstration of Electrically Detected Magnetic Resonance and Near Zero Field Magnetoresistance in Packaged SiC MOSFETs**

Colin G. McKay¹, David R. Hughart¹, Gaddi S. Haase¹
1. Sandia National Laboratories, Albuquerque, NM 87123

Electrically detected magnetic resonance (EDMR) and near zero field magnetoresistance (NZFMR) have been demonstrated to be very powerful tools in the study of performance limiting atomic scale defects in semiconductors and dielectrics.¹⁻³ The ability to integrate these measurements with electrical reliability testing would allow for an increased understanding of the defects that are generated during accelerated aging tests as well as providing a fairly simple test to identify changes in the numbers and types of defects formed during wafer processing and device stressing. This work demonstrates the first application of such EDMR and NZFMR measurements in packaged test structures which are compatible with standard 28-pin dual-inline-package (DIP) electrical reliability testing equipment. The EDMR and NZFMR spectra in this work were measured in planar SiC MOSFETs. Sandia National Laboratories is a multimission laboratory managed and operated by National Technology & Engineering Solutions of Sandia, LLC, a wholly owned subsidiary of Honeywell International Inc., for the U.S. Department of Energy's National Nuclear Security

Administration under contract DE-NA0003525.

- [1] Moxim et al., Appl. Phys. Lett. 2022, 120, 063502.
- [2] Sharov et al., Trans. Dev. Mat. Rel., 2022, 22, 322.
- [3] Ashton et al., Trans. Nuc. Sci., 2019, 66, 428.

EPR ORAL SESSION

Colin G McKay, Sandia National Laboratories, 6001 Imperata Street NE #1012, Albuquerque, New Mexico, 87111, United States
Tel: 5052844275, E-mail: cgmckay@sandia.gov

141 **Rapid Scan ESR: A Versatile Tool for the Spin Relaxation Studies at (sub)THz Frequencies**

O. Laguta¹, M. Sedivy¹, V.T. Santana¹, A. Sojka^{1,2}, A. Marko¹, P. Neugebauer¹

- 1. CEITEC—Central European Institute of Technology, Brno University of Technology, Purkyňova 123, 61200 Brno, Czech Republic
- 2. ITST - Institute of Terahertz Science and Technology, University of California, Santa Barbara, CA 93106-4170

The development of pulse electron spin resonance spectroscopy at microwave frequencies above 100 GHz is rather challenging and expensive task due to the low output power of modern high-frequency solid-state electronics. However, there is a number of scientific problems, e.g., DNP enhancement of NMR, that require spin relaxation measurements at THz frequencies. The rapid scan ESR is an alternative technique that does not require high microwave power and still provides information on the spin relaxation times. The method takes advantage of fast sweeps of the excitation microwave frequency over the ESR line. When the frequency sweep reaches a sufficiently high rate, distinct oscillations (also called wiggles) appear in the spectrum¹⁻³. It is possible to retrieve the undistorted (slow-scan) spectrum by employing the Fourier Transform analysis as Josef Dadok had demonstrated in NMR⁴. On the other hand, these oscillations bear information about the electron spin-spin relaxation time, which can be extracted via fitting the rapid scan spectrum using the modified Bloch equations. This technique allows one to capture the spin-spin relaxation time at the nanosecond time scale. Furthermore, the particular design of modern high-frequency ESR spectrometers greatly facilitates the multifrequency operation bringing the spin relaxation measurements to an unprecedentedly broad range of magnetic fields using only one ESR spectrometer (Fig. 1). Finally, we will discuss the future steps necessary to make the THz rapid scan ESR a convenient and easy to use tool for the broad scientific community.

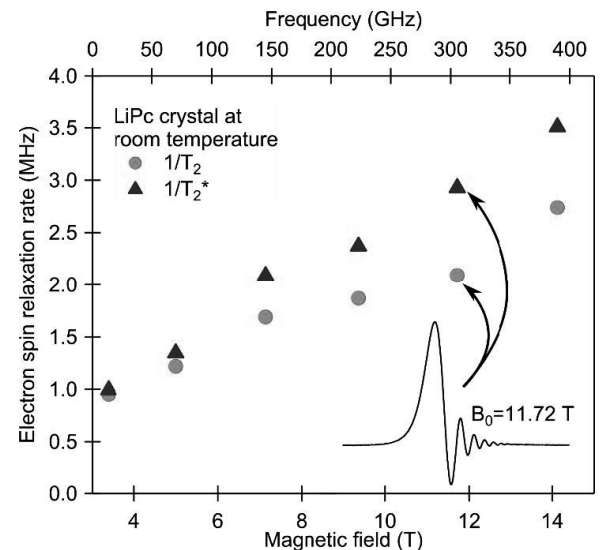

Fig.1 Magnetic field dependence of the electron spin relaxation times T₂ and T₂^{*} in LiPc at room temperature.

- [1] J. W. Stoner et al., Journal of Magnetic Resonance 2004, 170, 127.
- [2] O. Laguta, M. Tuček, J. van Slageren and P. Neugebauer, Journal of Magnetic Resonance 2018, 296, 138.
- [3] O. Laguta, A. Sojka, A. Marko and P. Neugebauer, Applied Physics Letters 2022, 120, 120502.

[4] J. Dadok and R. F. Sprecher, Journal of Magnetic Resonance (1969), 1974, 13, 243.

EPR ORAL SESSION

Petr Neugebauer, Central European Institute of Technology, Brno University of Technology, Purkynova 123, Brno, Jihomoravsky kraj, 61200, Czech Republic
E-mail: petr.neugebauer@ceitec.vutbr.cz

142 Time-Frequency Analysis of Two-Dimensional Electron Spin Resonance Signals

Gyana Ranjan Sahoo,¹ Aritro Sinha Roy,^{1,2} Madhur Srivastava^{1,2}

1. Department of Chemistry and Chemical Biology, Cornell University, Ithaca, NY, USA -14853

2. National Biomedical Resources for Advance ESR Technologies (ACERT), Ithaca, NY, USA -14853

Two-dimensional electron spin resonance (2D ESR) spectroscopy is a unique experimental technique in probing protein structure and dynamics, including processes that occur at microsecond time scale. While it provides significant resolution enhancement over the one-dimensional experimental set up, spectral broadening and noise make extraction of spectral information highly challenging. Traditionally, two-dimensional Fourier transform (2D FT) is applied for the analysis of 2D ESR signals, although its efficiency is limited to stationary signals. In addition, it often fails to resolve overlapping peaks in 2D ESR. We propose a time-frequency analysis (TFA) of 2D time domain signals in this work, which identifies all the frequency peaks by decoupling a signal into its distinct constituent components via projection on the time-frequency plane. The method utilizes 2D Undecimated Discrete Wavelet Transform (2D-UDWT) using Coiflet-3 wavelet for the signal decomposition. Application of 2D UDWT yields N number of Approximation, Horizontal, Vertical and Diagonal components, each having dimension similar to the input data, where N is the maximum number of decomposition level. The signal decomposition was followed by signal reconstruction from each of the wavelet components, zeroing the remaining components, and application of 2D FT to produce 4×N frequency domain spectral component. We have applied the method to a simulated 2D double quantum coherence (DQC) signal for validation and a set of experimental 2D ESR signals, demonstrating its efficiency in resolving overlapping peaks in the frequency domain, while displaying frequency evolution with time in case of non-stationary data.

Supported by the National Institute of General Medical Sciences/National Institutes of Health grant R24GM146107 and in part by the Cornell internal funding.

[1] Sahoo et al., Time-Frequency Analysis of Two-Dimensional Electron Spin Resonance Signals, (under review at the Journal of Physical Chemistry for the Early-Career and Emerging Researcher).

EPR ORAL SESSION

Gyana Ranjan Sahoo, Cornell University, 122 Baker Laboratory, Ithaca, New York, 14853, United States
Tel: 6072297887, E-mail: gs582@cornell.edu

143 Photonic Band Gap Resonators for mm-Wave Pulsed EPR

Alex I. Smirnov, Sergey Milikisiyants, Antonin Marek, and Alexander A. Nevzorov

Department of Chemistry, North Carolina State University, Raleigh, NC, 27695-8204, USA

In pulse EPR experiments considerations of cavity ringdown dictate to increase bandwidth/ lower quality factor of the resonator till an acceptable dead time is reached. However, the large resonator bandwidth also results in lower sensitivity of pulse EPR vs. continuous wave (CW) detection. The resonator conversion factor is also decreased, and this necessitates the use of high-power microwave amplifiers (ca. 1 kW at X-band) to take the full advantage of the excitation bandwidth. Fortunately, these technical considerations become relaxed by carrying out experiments at high frequencies/ high magnetic fields (HF EPR): the resonator bandwidth increases proportionally with frequency at the same Q-factor. Here, we demonstrate that resonators with Q-factor of at least 8,000 at 95 GHz (W-band) and 1,000 (198 GHz) can be constructed based on one-dimensional photonic band gap (PBG) crystals assembled from $\lambda/4$ low-loss dielectric layers with alternating dielectric constants. The use of low loss /high- ϵ materials improved the resonator finesse values up to ca. 50% of the Q-factor. Conversion factors of these resonators were evaluated in nutation experiments using 100 μm thick polystyrene film doped with 1 mM of BDPA. While the shortest 90° pulses for the best PBG resonators were still 50% longer vs. those achieved with cylindrical TE₀₁₂-type cavity of comparable Q (34 ns vs. 23 ns, respectively) when using only 0.6 W of incident power generated by all-solid-state devices, an increase in sample volume from 0.8 to 120 μl resulted in >60-fold signal gain for the same spin concentration.

Supported by NIH R01GM130821.

EPR ORAL SESSION

Alex I Smirnov, North Carolina State University, 2620 Yarbrough Drive, Raleigh, North Carolina, 27695-8204, United States
Tel: 9195134377, E-mail: Alex_Smirnov@ncsu.edu

144 Quasi-optical Sample Holder with Order-of-magnitude Improvement in Signal to Noise Ratio for a Frequency-agile Electron Magnetic Resonance Spectrometer Powered by Free-electron Laser

Antonin Sojka, Brad D. Price, Nikolay Agladze, Mark S. Sherwin
University of California, Santa Barbara, CA, USA

The development of high field Electron Paramagnetic Resonance (hfEPR) spectrometers is an active field of research. Typically, hfEPR spectrometers over 200 GHz operate in induction mode, meaning only polarization orthogonal to the excitation polarization is detected. Further, hfEPR spectrometers rarely employ resonant cavities because excitation wavelengths shrink with increasing frequency. While usually capable of isolating the excitation polarization by about 30 dB, induction mode architectures still impart a significant background to EPR experiments, as the excitation power is typically much larger than the orthogonal induction mode signal; as a result, improving induction-mode isolation for high field-and-frequency experiments is a potential avenue for improving hfEPR resolution.¹ The aim of our work is to design and implement a general-purpose state-of-the-art broadband hfEPR spectrometer. Our design uses UCSB's free electron laser (FEL) as the source of frequency-agile kW power that operates at frequencies from 170 GHz to 450 GHz, and at magnetic fields up to 16 T.² The spectrometer is meant to operate in pulsed, continuous wave and rapid-scan mode. A key component of the new spectrometer is a resonator-free, 3D-printed quasi-optical sample holder for improving the signal-to-noise ratio (SNR) and induction mode isolation.³ An adjustable positioner allows for optimizing sample position to maximize the magnetic field B₁ of incident microwaves, and a rooftop mirror allows for small rotations of the cross-polar signal to maximize the signal and minimize the co-polar background. When optimized, the co-polar isolation is improved over 20 dB to around 50 dB resulting in greatly improved SNR in field domain modes (cw and rapid-scan, approx. 6x) as well as pulsed mode (approx. 2x).

This work was supported by NSF-DMR 2117994.

[1] Cruickshank, P. A. et al., Rev Sci Instrum, 2009, 80, 103102.

[2] Takahashi, S. et al., Nature, 2012, 489, 409.

[3] Sojka et al., arXiv:2305.01820, 2023.

EPR ORAL SESSION

Antonin Sojka, University of California, Santa Barbara, Broida Hall UCSB, Santa Barbara, California, 93106, United States

Tel: 8052599096, E-mail: antonin_sojka@ucsb.edu

145 1 GHz EPR Imaging of Small Numbers of Nitroxide Spins Using Rapid Scan Direct Detection.

Lukas B. Woodcock,¹ Hanan B. Elajaili,² Tanden A. Hovey,¹ George A. Rinard,¹ Samuel DeGraw,¹ Autumn Canny,¹ Joseph P. Y. Kao,³ Eva S. Nozik,² Sandra S. Eaton¹ and Gareth R. Eaton¹

1. Department of Chemistry and Biochemistry, University of Denver, Denver, CO 80208 USA

2. Pediatric Critical Care Medicine, University of Colorado Anschutz Medical Campus, 12700 E. 19th Ave., B131, Aurora CO 80045 USA

3. Center for Biomedical Engineering and Technology and Department of Physiology, University of Maryland School of Medicine, Baltimore, MD USA

A rapid scan EPR spectrometer operating at a microwave frequency of about 1 GHz achieves a spin sensitivity of $\sim 2 \cdot 10^{14}$ spins in an aqueous nitroxide sample in a 9 mm diameter resonator. The magnet and rapid scan driver and coils are similar to those reported by Buchanan et al.^[1], but the signal detection path was simplified to minimize loss and increase detection sensitivity. One application, reported separately by Hanan Elajaili, measured nitroxide radicals in excised lungs. The small number of radicals trapped results in low signal-to-noise in the spectra and images. However, since the spectral properties of the nitroxides are known, we can use the prior knowledge of the line shape and hyperfine splitting to fit the noisy data, yielding well-defined images. Two-dimensional spectral-spatial images are shown for lung samples containing $(4.5 \pm 0.5) \cdot 10^{14}$ and $(9.9 \pm 1) \cdot 10^{14}$ spins.

Supported by NIH RO1CA1262159 (GRE) and R33 HL157907 (ESN and SSE).

[1] L. A. Buchanan, G. A. Rinard, R. W. Quine, S. S. Eaton, and G. R. Eaton, Tabletop 700 MHz EPR Imaging Spectrometer, Conc. Magn. Reson. B, Magn. Reson. Engin. 48B, e21384, (2018), doi 10.1002/cmr.b.21384.

EPR ORAL SESSION

Lukas B Woodcock, University of Denver, 2101 E Wesley Ave, Denver, Colorado, 80210, United States

Tel: 9892132752, E-mail: lukas.woodcock@du.edu

146 Rapid-scan-enabled Time-resolved Gd-Gd EPR for “Filming” a Protein at Physiological Temperatures

Brad D. Price,¹ Shiny Maity², Antonin Sojka¹, Maxwell Z. Wilson³, Songi Han², and Mark S. Sherwin¹

1. University of California Santa Barbara, Department of Physics, Santa Barbara, CA 93106

2. University of California Santa Barbara, Department of Chemistry, Santa Barbara, CA 93106

3. University of California Santa Barbara, Department of Molecular, Cellular, and Developmental Biology, Santa Barbara, CA 93106

Proteins are fundamental building blocks of life; understanding their function is key to understanding biological processes. Recent EPR structural analyses of proteins, including Gd-DEER and nitroxide rapid freeze-quench techniques, provide static distance distributions at various times after activation.¹ However, an in-depth functional understanding of proteins requires a technique for tracking their inter-residue movement in real time. Such techniques exist, and include time-resolved (tr) X-ray spectroscopy, tr IR spectroscopy, tr NMR, and Förster resonance energy transfer, though the latter presents challenges when working with light-activated proteins. We present a technique called “rapidscan-enabled, high-field, 240 GHz time-resolved Gd-Gd EPR” (TiGGER) that is capable of time-resolved, solution state measurements of spin-spin distances between 1-4 nm, and demonstrate it on AsLOV2, a light-activated protein found in oats.² TiGGER makes use of rapidscan EPR with Gd-STPATCN spin labels to return a set of time-resolved, dipolar broadened spectra: these spectra contain all the information necessary to extract intra-protein spin-spin distance. Using TiGGER, we were able to make a direct measurement confirming reports from others that upon illumination, AsLOV2’s J α -helix unfolds and becomes disordered.³ Additionally, using TiGGER, we determined that increasing temperature causes the photocycle of AsLOV2 to proceed faster and may also cause the protein to become more compact in the dark state. Next steps for this method include developing a method to extract quantitative distances using TiGGER as well as improving temporal resolution in order to capture faster dynamics.

We acknowledge financial support from NSF MCB-2025860 and UC Research Initiative MRI-19-601107.

[1] Potapov and Goldfarb, *Appl. Magn. Reson.*, **2010**, 37, 845.

[2] Harper, Neil, and Gardner, *Science*, **2003**, 301, 1541.

[3] Maity et al., *Angew. Chem., Int. Ed.*, **2023**, 62, e202212832.

EPR ORAL SESSION

Brad D. Price, UC Santa Barbara, 6115 Coloma Dr., Unit B, Goleta, California, 93117, United States

E-mail: bdprice@ucsb.edu

147 A Simulation Independent Wavelet-Based Approach for cw ESR Spectral Analysis

Aritro Sinha Roy^{1,2}, Boris Dzikovski², Dependu Dolui³, Olga Makhlynets⁴, Arnab Dutta,³ and Madhur Srivastava^{1,2}

1. Department of Chemistry and Chemical Biology, Cornell University, Ithaca, NY 14853, USA

2. National Biomedical Resource for Advanced ESR Spectroscopy, Cornell University, Ithaca, NY 14853 USA

3. Department of Chemistry, Indian Institute of Technology Bombay, Mumbai 400076, India

4. Department of Chemistry, Syracuse University, Syracuse, NY 13244, USA

The accurate analysis of continuous-wave electron spin resonance (cw ESR) spectra of biological or organic free-radicals and paramagnetic metal complexes is key to understanding their structure–function relationships and electrochemical properties. The current methods of analysis based on simulations often fail to extract the spectral information accurately. In addition, such analyses are highly sensitive to spectral resolution and artifacts, users’ defined input parameters and spectral complexity. We introduce a simulation-independent spectral analysis approach that enables broader application of ESR. We use a method based on wavelet packet transform (WPT) for extracting g-values and hyperfine (A) constants directly from cw ESR spectra. Three major accomplishments of our method over standard simulations are: (1) direct extraction of nitrogen-hyperfine structure from poorly resolved and unresolved spectra, (2) insensitivity toward spectral artifacts and (3) identification of multi-component samples. The validation of the method is showcased by the consistent extraction of the proton superhyperfine coupling constant from both partially resolved and unresolved spectra of Tempol. The limitations of standard simulation-based ESR spectral analysis are illustrated for poorly resolved experimental spectra of copper-nitrogen complexes, with one of the cases containing some experimental artifacts. While the accuracy and efficiency of the simulations vary drastically in such cases, the WPT-based analysis extracted spectral parameters in an accurate and consistent manner across all the cases. Additionally, we demonstrate that for a two-component system, the method identifies their individual spectral features even when the minor component is present in very low amount.

Supported by the National Institute of General Medical Sciences/National Institutes of Health grant R24GM146107.

[1] Sinha Roy et al., *Magnetochemistry*, 2022, 8(3), 32

EPR ORAL SESSION

Arito Sinha Roy, Cornell University, 190 Pleasant Grove Road, P5, ITHACA, New York, 14850, United States

Tel: 6072616710, E-mail: as836@cornell.edu

148 Site Directed Spin Labeling and Integrative Protein Modeling with chiLife

Maxx H. Tessmer, [Stefan Stoll](#)

Department of Chemistry, University of Washington, Seattle, WA, United States

Site directed spin labeling (SDSL) EPR is a powerful tool for investigating protein structure, dynamics and membrane interactions. Quantitative integration of information from SDSL EPR experiments such as DEER spectroscopy into protein structure models requires flexible spin label modeling methods to accurately account for label structure and dynamics. We provide an overview of chiLife,¹ an SDSL modeling package written in Python that facilitates quantitative analysis of SDSL EPR data in the context of protein models.² It implements established spin label modeling methods like accessible volume and rotamer libraries, as well as a new approach based on off-rotamer sampling.³ It includes novel methodology for modeling bifunctional spin labels like RX and di-histidine Cu(II).⁴ These novel approaches are validated against experimental data. chiLife can be integrated with Python-interfaced protein modeling software like Rosetta and Xplor-NIH.

[1] <https://pypi.org/project/chilife/>

[2] M. H. Tessmer, E. R. Canarie, S. Stoll, Biophys. J. 121, 3508-3519, 2022.

[3] M. H. Tessmer, S. Stoll, PLoS Comput. Biol. 19(3), e1010834, 2023.

[4] M. H. Tessmer, S. Stoll, submitted, 2023.

EPR ORAL SESSION

Stefan Stoll, University of Washington, Department of Chemistry, Box 351700, Seattle, Washington, 98195, United States

Tel: 2065432906, E-mail: stst@uw.edu

149 A Wavelet-based Approach to Background Correction in Pulsed Dipolar Spectroscopy

[Karen Tsay](#)^{1*}, Vishnu Vijayan¹, Yann Fichou², Songi Han^{1,3}, Madhur Srivastava^{4,5}

1. Department of Chemistry and Biochemistry, University of California Santa Barbara, Santa Barbara, USA

2. Institute of Chemistry and Biology of Membranes and Nano-object, French National Centre for Scientific Research, Bordeaux, France

3. Department of Chemical Engineering, University of California Santa Barbara, Santa Barbara, USA

4. Department of Chemistry and Chemical Biology, Cornell University, Ithaca, USA

5. National Biomedical Center for Advanced ESR Technology, Cornell University, Ithaca, USA

Pulsed dipolar electron spin resonance spectroscopy is a unique tool to study disordered systems and their transition to ordered states due to its ability of obtaining not only the mean distance, r , between a pair of spin labels, but also the probability distribution of distances, $P(r)$, whose shape can offer information about whether a defined distance, multiple distances, or a broad ensemble of distances are populated.^{1,2} The $P(r)$ is encoded by a time domain signal that contains a background signal that must be treated before $P(r)$ can be extracted.³ Current approaches are unable to properly treat background signal of biological sample with unclear separation between signal and background. We present a simple background correction method utilizing wavelet transform to accurately select the background, fit the background, and then remove by subtraction in the logarithmic domain. We demonstrate this method on simulated $V(t)$ and experimental $V(t)$ of the intrinsically disordered protein, tau, and its fibrillar state.

Supported by NIH-1R35GM136411-01.

[1] Jeschke and Polyhach, Chem.Chem. Phys. 2007, 9(16), 1895-1910.

[2] Borbat et al., Methods Enzymol. 2007, 423, 52-116.

[3] Fábregas Ibáñez et al., Chem. Chem. Phys., 2020, 22(4), 1855-1868.

EPR ORAL SESSION

Karen Tsay, University of California-Santa Barbara, 5221 Cheadle Hall, Santa Barbara, California, 93106, United States

Tel: 9162541923, E-mail: ktsay@ucsb.edu

150 Oxygen Enhanced EPR Imaging for Evaluations of Radiotherapy in Preclinical Tumor Models

TianzheLi,^{1,2} Jorge de la Cerda,¹ F. William Schuler,¹ [Mark D. Page](#)¹

1. Department of Cancer Systems Imaging, University of Texas MD Anderson Cancer Center, Houston TX, USA

2. University of Texas Health Science Center, Houston, TX, USA

EPR imaging can measure the partial pressure of oxygen (pO_2) in tumors by measuring the T1 relaxation time of an

OX071 agent along with a T1-pO₂ calibration. Furthermore, medical grade air (21% O₂) and 100% O₂ can be used as the carrier gas during anesthesia. The difference in pO₂ (Δ pO₂) measured with each carrier gas is an additional biomarker for evaluating radiotherapy studies. To evaluate the precision of pO₂ and Δ pO₂ measurements, we scanned an orthotopic tumor model of 4T¹ breast cancer twice with both carrier gases, using a 300 MHz Biospec MRI scanner (Bruker Biospin) and a 720 MHz Jiva-25 EPRI scanner (O2M Technologies). The average pO₂ values were 24.5 torr and 36.1 torr with 21% O₂ and 100% O₂ gas, respectively, which was significantly different ($p = 0.038$) and moderately correlated among the mice ($R^2 = 0.65$). The mean variation of test-retest between the two pO₂ scans was 2.6 torr with 21% O₂ and 100% O₂ gases, showing an excellent average repeatability of 9.8%.

To investigate the merit of Δ pO₂ for radiotherapy studies, we scanned subcutaneous tumor models of Colo 357 and SU.86.86 pancreatic cancer, with 21% O₂ gas and 100% O₂ gas, and 1 day before and 1 day after 10 Gy radiotherapy. The decrease in pO₂ before and after radiotherapy was not significant when using 21% O₂ gas ($p = 0.28, 0.21$ for each model), and was not significant or only mildly significant when using 100% O₂ ($p=0.031, 0.092$). The decrease in Δ pO₂ was highly significant ($p < 0.001$ for both models). The effect size was 0.47-0.98 for pO₂ measurements using either carrier gas, and was 1.59-2.41 for Δ pO₂. Therefore these results show that Δ pO₂ is a superior biomarker when evaluating the early tumor response to radiotherapy. Collectively, our research establishes our Oxygen Enhanced EPRI/MRI protocol for preclinical studies of radiotherapy.

Our research is supported by the NIH/NCI through grants R01 CA231513 and P30 CA016672. We thank O2M Technologies for access to a JIVA-25 EPRI instrument, and for their consultation.

[1] Epel B, Kotecha M, Halpern H. In vivo preclinical cancer and tissue engineering applications of absolute oxygen imaging using pulse EPR. J Magn Reson 2017;280:149-157.

EPR ORAL SESSION

Marty Pagel, MD Anderson Cancer Center, 3SCR4.3642, 1881 East Road, Houston, Texas, 77054, United States
Tel: 7132058515, E-mail: mdpagel@mdanderson.org

151 Behind BBB: Trityl-based Oxygen Imaging of Systemic Neuroinflammation in Mice

Boris Epel^{1,2}, Safa Hameed², Navin Viswakarma², Mona M Freidin³, Charles K Abrams³, and Mrignayani Kotecha²

1. Department of Radiation and Cellular Oncology, The University of Chicago, Chicago, IL 60637, USA

2. Oxygen Measurement Core, O2M Technologies, LLC, Chicago, IL 60612, USA

3. Department of Neurology and Rehabilitation, University of Illinois at Chicago, Chicago, IL 60612, USA

Neuroinflammation is one of the main mechanisms involved in the progression of neurodegenerative diseases that leads to the progressive loss of brain functions. One of the key characteristics of neurodegenerative diseases is the damage to the blood-brain barrier (BBB). The purpose of this proof-of-concept study was to assess the ability of trityl OX071-based pulse electron paramagnetic resonance imaging (pEPRI) to detect the leakage in the BBB and provide partial oxygen pressure (pO₂) maps in the mouse brain with disease progression. Neuroinflammation was induced by lipopolysaccharide (LPS) injection in Cx32-knockout mice.

OX071 is believed to show no BBB penetration, however, the traces of the spin probe (about 10% of signal intensity compared to highly vascularized tissues) were found in the intact brain. An increase in brain signal intensity compared to the intact brain was observed indicating the increased leakage of BBB with the disease progression. The high sensitivity of the 720 MHz pEPRI oxygen imager allowed us to get the pO₂ maps of the brain during disease progression. For the first time, we show the ability of pEPRI to observe the disruption of BBB along with providing pO₂ maps in the neuroinflammatory mice. We expect that this study will open new queries from the field to explore the pathology of neurodegenerative disease progression and provide a path to new treatments.

EPR ORAL SESSION

Boris Epel, University of Chicago, 5801 S. Ellis Ave., Chicago, Illinois, 60637, United States
E-mail: bepel@uchicago.edu

152 Nondestructive, Longitudinal, 3D Cell Viability Assessment in a Multi-Well Plate System Using EPR Oxygen Imaging

Safa Hameed¹, Navin Viswakarma¹, Greta Babakhanova², Carl Simon², Boris Epel^{1,3}, and Mrignayani Kotecha^{1*}

1. Oxygen Measurement Core, O2M Technologies, LLC, 2201 W Campbell Park Dr., Chicago, IL 60612, USA.

2. National Institute of Standards and Technology, Biosystems & Biomaterials Division, 100 Bureau Drive, Gaithersburg, MD 20899, USA

3. Department of Radiation and Cellular oncology, The University of Chicago, IL 60637, USA.

Cell viability is an essential measurement for cell therapy, tissue-engineered medical products (TEMPs), drug development, and many other biological processes and products. These systems rely on viable, healthy, and functional cells to work as intended. Commonly used methods to assess cell viability, such as MTT, PicoGreen, or Luciferase assays, to measure cell viability are destructive and are inadequate for cell-plus-scaffold systems. The use of oxygen by cells and

tissues is an essential aspect of basic redox biology. Here, we report the noninvasive cell viability assessment using trityl OX071-based electron paramagnetic resonance oxygen imaging (EPROI) in a standard 96-well plate. All measurements were performed using O2M's preclinical EPROI instrument named JIVA-25™, a 25 mT instrument operating at 720 MHz radiofrequency.

We developed a novel multi-well plate incubator-resonator (MWIR) platform in conjunction JIVA-25™ to perform pO₂ imaging of live cells in 96-well plates during planar 2D culture and during culture in a 3D hydrogel scaffold. The MWIR performs the pO₂ imaging in the middle twelve wells of three strip wells while maintaining the temp. at 37 °C and the constant flow of humidified gas mixture (f.e. 95% air & 5% CO₂) to maintain the incubator-like environment. The pO₂ maps of cells allow the assessment of viable and functional cells without destroying or sectioning them in the process. The MWIR system allows the longitudinal OCR measurements up to 24 hours while keeping the cells viable. We performed the cell viability measurements for the adherent HEK 293 cells, non-adherent Jurkat cells, and Jurkat cells in VitroGel.

This work demonstrates the noninvasive cell viability assessment using EPR oxygen imaging. We show that three-dimensional pO₂ maps are indicative of functional and viable cells. We show that the functional/viable cells can be visualized using oxygen maps longitudinally without destroying them in the process. Using an adherent cell line (HEK-293) and a non-adherent cell line (Jurkat), we demonstrate the importance of three-dimensional cell viability assessment. Finally, we demonstrate the feasibility of cell viability assessment nondestructively in a cell-scaffold system comprising Jurkat cells and VitroGel, thus opening a new era of cell viability measurements in artificial tissue grafts. This nondestructive cell viability measurement could be used to optimize therapeutic doses for cell therapies, TEMPLs, and drug toxicity studies and provides a new and innovative view of living cells in these systems. The approach is suitable for any tissue or organ of arbitrary sizes and may become a standard tool in biology.

Acknowledgement: NSF grant 2028829 to O2M (PI: Kotecha)

EPR ORAL SESSION

Mrignayani Kotecha, O2M Technologies, LLC, 2201 W Campbell Park Dr., Chicago, Illinois, 60612, United States
E-mail: mkotecha@oxygenimaging.com

153 A Data Processing Approach for High Resolution Electron Spin Resonance Imaging

Nimesh Srivastava,¹ Jack Freed,^{1,2} Madhur Srivastava^{1,2}

1. Department of Chemistry and Chemical Biology, Cornell University, Ithaca, NY, USA -14853

2. National Biomedical Resources for Advanced ESR Technologies (ACERT), Ithaca, NY, USA -14853

Electron Spin Resonance Imaging (ESRI) permits measurement of tissue oxygen status quantitatively and non-invasively. It has been shown to be effective in live animals infused with stable paramagnetic probes. However, ESRI's translation into clinical settings has been obstructed by the low probe dosage (Oxo-63) allowed for humans. A typical Oxo-63 dose for live animals is in the 0.5–1.5 range for ESRI, but for ESRI feasibility in humans, the dose must be reduced to 50, an order-of-magnitude reduction. This reduction inevitably weakens the signal strength, lowering the signal-to-noise ratio (SNR). Reduction in signal acquisition times is required to obtain an acceptable SNR, which is currently impractical in clinical imaging. Improvement in SNR is absolutely critical to enable the effective use of ESRI by reducing acquisition time and lowering dosage of ESRI in humans. An alternate approach is needed to improve SNR by eliminating noise, while maintaining the integrity of the original signal. To address this problem, we have developed a SF-SVD approach that utilizes Singular Value Decomposition (SVD) to decompose the 2D signal of $M \times N$ dimension into a singular value matrix of $M \times N$ dimension and two matrices of orthonormal basis vector sets of $M \times M$ dimension and $N \times N$ dimension, respectively. SF-SVD takes a different approach by denoising the data point-wise. This means that each and every point will have different threshold of singular values according to the noise present in it. Our implementation of SF-SVD on ESRI data has demonstrated comparable SNR to that of signal averaging, while simultaneously reducing the total scan time required for ESRI by 50%.

[1] Srivastava et al., USPTO Application No. 63/479,287, 2023.

EPR ORAL SESSION

Nimesh Srivastava, Cornell University, 259 Feeney Way, Ithaca, New York, 14850, United States
E-mail: ns939@cornell.edu

200 Towards Spectroscopic Observation of Electric Field-Effects on Molecular Nanomagnets

Francisca Abdo Arias¹, Tanmai Pathak¹, Brendan C. Sheehan², Guanchu Chen², Rafael A. Allão Cassaro³, Thomaz A. Costa³, Jonathan R. Friedman¹

1. Amherst College, Department of Physics, Amherst, MA 01002

2. University of Massachusetts Amherst, Department of Physics, Amherst, MA 01002

3. Instituto de Química, Universidade Federal do Rio de Janeiro, Rio de Janeiro, RJ 21941-909, Brazil

Electric fields can alter the anisotropy of molecular nanomagnets (MNMs), changing the observed spin dynamics.¹ We designed and built an apparatus to perform EPR experiments on MNMs with the goal of understanding how the application of a DC electric field to a crystalline MNM sample can affect its EPR spectra. Miniature capacitor plates placed in a loop-gap resonator allow us to apply a static electric field of controlled strength on the order of 10^5 V/m directly to our sample while measuring its EPR CW spectrum. By exchanging 3D-printed parts in the apparatus, we can perform experiments in both parallel and perpendicular modes, and by rotating the orientation of the capacitor plates we can control the direction of the external electric field relative to the DC magnetic field. We present preliminary studies using our apparatus on the $[\text{Ni}(\text{hmp})(\text{dmb})\text{Cl}]_4$, or Ni_4 , single-molecule magnet (SMM). Ni_4 is a four-fold symmetric SMM that exhibits Berry phase interference in the quantum tunneling of magnetization when a transverse magnetic field is applied in the hard plane of the crystalline sample², breaking the symmetry of the molecule. We investigate whether the application of a DC electric field can produce similar symmetry breaking in Ni_4 .

Supported by NSF grant no. DMR-2207624.

[1] J. Liu, J. Mrozek, A. Ullah, Y. Duan, J. J. Baldoví, E. Coronado, A. Gaita-Ariño, and A. Ardavan, "Quantum Coherent Spin-Electric Control in a Molecular Nanomagnet at Clock Transitions" *Nat. Phys.* 1 (2021).

[2] B. C. Sheehan, R. Kwork, C. A. Collett, T. A. Costa, R. A. A. Cassaro, and J. R. Friedman, "Direct Spectroscopic Observation of Berry-Phase Interference in the Ni_4 Single-Molecule Magnet" *Phys. Rev. B* 102, 224428 (2020).

EPR POSTER SESSION

Francisca I. B. Abdo Arias, Amherst College, 220 South Pleasant Street, Amherst, Massachusetts, 01002, United States
E-mail: fabdoarias24@amherst.edu

201 A Preliminary Study on the Spin Sensitivity of Near Zero Field Magnetoresistance Spectroscopy

Elijah A. Allridge¹, Patrick M. Lenahan¹

1. Penn State University, Department of Engineering Science and Mechanics, University Park, PA 16802

Near Zero Field Magnetoresistance (NZFMR) spectroscopy is a new electron spin technique related to electrically detected magnetic resonance, which is particularly useful for semiconductor device physics problems. While some work has been done to extract the spin defect information^{1,2}, to our knowledge there has been no publications relating to the absolute sensitivity to spin defects. We have utilized the Fitzgerald-Grove method of calculating interface spin density in MOSFETs, then related that to the signal intensity of the NZFMR response. The preliminary results we have found shows a room temperature sensitivity of less than 1,000 spins, which is slightly more sensitive than the sensitivity of electrically detected magnetic resonance, which sits around a minimum of 1,000 spins. This sensitivity, as well as the great simplicity of the apparatus required to perform the measurement, bodes well for NZFMR being a valuable tool in the development of today's nanoelectronic devices.

[1] Frantz et al., *J. Appl. Phys.*, **2020**, 128, 124504.

[2] Frantz et al., *J. Appl. Phys.*, **2021**, 130, 065701.

[3] Fitzgerald & Grove, *Surface Sci.*, **1968**, 9, 347.

EPR POSTER SESSION

Elijah A Allridge, Penn State University, 212 Earth and Engineering Science, University Park, Pennsylvania, 16802, United States

E-mail: eaa5388@psu.edu

202 Electron Spin Relaxation of the SO_2^- and SO_3^- Radicals in $\text{Na}_2\text{S}_2\text{O}_4$, $\text{Na}_2\text{S}_2\text{O}_5$, and $\text{K}_2\text{S}_2\text{O}_5$

Georgina Amassah, Deborah G. Mitchell, Tanden Hovey, Sandra S. Eaton, and Gareth R. Eaton

Department of Chemistry and Biochemistry, University of Denver, Denver CO 80208 USA

Electron spin relaxation times are reported for the SO_2^- radical in solid $\text{Na}_2\text{S}_2\text{O}_4$ and $\text{K}_2\text{S}_2\text{O}_5$ and for SO_3^- in $\text{Na}_2\text{S}_2\text{O}_5$ and $\text{K}_2\text{S}_2\text{O}_5$. Commercial samples of powders of $\text{Na}_2\text{S}_2\text{O}_4$, $\text{Na}_2\text{S}_2\text{O}_5$, and $\text{K}_2\text{S}_2\text{O}_5$ were used as received. Radicals were observed in these as-prepared salts in the 1950s, and also upon irradiation. The crystal structures of $\text{Na}_2\text{S}_2\text{O}_4$ [1,2] revealed an unusually long S-S bond, so it was assumed that thermal dissociation of $\text{S}_2\text{O}_4^{2-}$ into two SO_2^- in the crystal was the cause of the radicals. The S-S bond length in $\text{S}_2\text{O}_5^{2-}$ (2.209 Å) [3,4] is intermediate between the long bond in $\text{S}_2\text{O}_4^{2-}$ (2.389 Å) and bond length in $\text{S}_2\text{O}_6^{2-}$ (2.15-2.16 Å) [4]. It was proposed that $\text{S}_2\text{O}_5^{2-}$ dissociates into an SO_2^- and an SO_3^- radical. The spin concentration in $\text{Na}_2\text{S}_2\text{O}_4$ corresponds to about 0.01% dissociation of the anions in the solids, consistent with prior reports [5,6]. T_m and T_1 were measured by spin echo methods from 40 to 293 K and by long-pulse saturation recovery at 293 K. Wide distributions of relaxation times were observed, which is attributed to variations in interspin distances. T_1 is shorter for SO_2^- than for SO_3^- . Although there have been multiple measurements of CW spectra and g values, this is the first study of relaxation of these anions.

- [1] J.D. Dunitz, *Acta Cryst.* 9 (1956) 579 - 586.
 [2] J.B. Weinrach, D.R. Meyer, J. Guy, J. T., P.E. Michalski, K.L. Carter, D.S. Grubisha, and D.W. Bennett, *J. Cryst. Spectros. Res.* 22 (1992) 291 - 301.
 [3] W.H. Zachariasen, *Phys. Rev.* 40 (1932) 923 - 925.
 [4] I. Lindqvist and M. Mörtzell, *Acta Cryst.* 10 (1957) 406 - 409.
 [5] W.G. Hodgson, A. Neaves, and C.A. Parker, *Nature* 178 (1956) 489.
 [6] E.G. Janzen, *Electron spin resonance study of the SO₂*. *J. Phys. Chem.* 76 (1972) 157 - 162.

EPR POSTER SESSION

Georgina Amassah, University of Denver, 2101 E. Wesley Ave, Denver, Colorado, 80210, United States
 E-mail: Georgina.Amassah@du.edu

203 Capturing an Elusive Seconds-timescale Conformational Change using Cu(II)-based EPR Coupled with Atomistic MD Simulations

Xiaowei Bogetti¹, Anthony Bogetti¹, Joshua Casto¹, Gordon Rule², Lillian Chong¹, Sunil Saxena¹

1. Department of Chemistry, University of Pittsburgh, Pittsburgh, Pennsylvania 15260

2. United States Department of Biological Sciences, Carnegie Mellon University, Pittsburgh, PA, 15213, USA

Pulsed EPR distance measurements using double histidine (dHis)-Cu(II) based spin labels have enabled efficient localization of a metal binding site,¹ precise determination of protein-nucleic acid interactions² and sensitive detection of conformational changes.³ However, relating the EPR distance to protein conformational changes has typically relied on computational models that are fast, but suffers from low resolution.⁴ In this talk, we discuss a new strategy that enables sampling conformational changes at atomic resolution by combining dHis-Cu(II) EPR and weighted ensemble molecular dynamics (MD) simulations. We have applied this strategy to sample a seconds-timescale conformational change in the homodimeric detoxification enzyme, human glutathione S transferase A1-1 (hGSTA1-1).^{5,6} First, we collected EPR distance distribution on a critical helix of hGSTA1-1 dimer as a function of ligand concentration. Using key information from the EPR results, we performed weighted ensemble MD simulations to generate atomistic transition pathways between the ligand-bound and newly resolved ligand-free states. Based on the simulations, the subtle change of 4 Å in the EPR distance distributions between the ligand-bound and ligand-free state surprisingly results from a large-scale conformational change. In addition, we found that the conformational transition is mutually exclusive between the two monomers within the hGSTA1-1 dimer, which suggests negative cooperativity. Such a cooperative mechanism, which is controlled by key residue-residue interactions, may be essential for the enzyme to protect cells from a broad range of toxins. This talk showcases the power of integrating EPR and atomistic enhanced MD simulation to understand the mechanism of a seconds-timescale conformational change in a functional enzyme at the atomic level.⁷

Supported by NSF MCB-2112871, NSF MRI 2117681 and Center for Research Computing at the University of Pittsburgh.

- [1] Gamble Jarvi A, Cunningham TF, Saxena S (2019) *Phys. Chem. Chem. Phys.* 21:10238–10243.
 [2] Sameach H, Ghosh S, Gevorkyan-Airapetov L, Saxena S, Ruthstein S (2019) *Angew. Chem.* 131:3085–3088.
 [3] Lawless MJ, Pettersson JR, Rule GS, Lanni F, Saxena S (2018) *Biophys. J.* 114:592–601.
 [4] Jeschke G (2018) *Protein Sci.* 27:76–85.
 [5] Zhan Y, Rule GS (2004) *Biochemistry* 43:7244–7254.
 [6] Nieslanik BS, Ibarra C, Atkins WM (2001) *Biochemistry* 40:3536–3543.
 [7] Bogetti X, Bogetti AT, Casto J, Rule GS, Chong LT, Saxena S (2023) Direct observation of negative cooperativity in a detoxification enzyme at the atomic level by EPR and simulation.

EPR POSTER SESSION

Xiaowei Bogetti, University of Pittsburgh, Chevron Science Center, 219 Parkman Ave, Pittsburgh, Pennsylvania, 15260, United States

Tel: 3022999714, E-mail: xid37@pitt.edu

204 DEER Spectroscopy Demonstrates the Link Between Conformational Heterogeneity and the Signaling Efficacy and Bias of Ligands for the beta-2-adrenergic Receptor (β2AR).

Patrick C. Brennan,¹ Biswaranjan Pani,² Marina Casiraghi,³ Robert J. Lefkowitz,² Brian K. Kobilka,³ Michael T. Lerch¹

1. Department of Biophysics, Medical College of Wisconsin, Milwaukee, WI 53226, USA

2. Department of Medicine and Howard Hughes Medical Institute, Duke University Medical Center, Durham, NC 27710, USA

3. Department of Molecular and Cellular Physiology, Stanford University School of Medicine, Stanford, CA 94305, USA

The β-adrenergic receptors (βARs) are a subfamily of G protein-coupled receptors (GPCRs) that are expressed by most cell types in humans; as such, signaling through βARs regulates a wide variety of physiological processes. Upon binding extracellular ligands, these receptors couple to G_s and G_i G-protein subtypes which reside at the intracellular side of the plasma membrane to trigger transducer specific downstream signaling events. Receptors exist as an ensemble of distinct conformations in dynamic equilibrium where each conformation translates functionally by possessing

distinct affinities and catalytic guanine nucleotide exchange factor (GEF) activities for Gs and Gi transducer proteins. The gaps in knowledge reside between resolved end-point structures of GPCRs where functionally relevant ligand-mediated conformational changes take place that may not be captured in available endpoint structures. Experimental techniques capable of characterizing structural differences of functionally distinct receptor conformations and their equilibrium populations in physiologic conditions are invaluable to further our understanding of ligand mediated GPCR signal transduction. Double Electron-Electron Resonance (DEER) overcomes the challenges that a high degree of conformational heterogeneity presents to most structural techniques. Using DEER, we are able to resolve each structure present in the conformational ensemble along with the relative equilibrium populations as each distance present contributes to the dipolar evolution. Using continuous wave (CW) and DEER spectroscopy we show that a Gi biased ligand stabilizes a conformation of the receptor similar to the Gi-coupled β 2AR, implicating conformational selection in biased GPCR signaling. Using DEER, we show a difference in the conformational heterogeneity and outward tilt of transmembrane helix 6 when the receptor is coupled to Gi vs Gs. We demonstrate how EPR spectroscopy is uniquely poised to detail the molecular mechanisms governing ligand mediated GPCR signal transduction.

EPR POSTER SESSION

Patrick Brennan, Medical College of Wisconsin, 8701 W Watertown Plank Rd, Wauwatosa, Wisconsin, 53226, United States

Tel: 4144055922, E-mail: pbrennan@mcw.edu

205 **Ground, Ping, Ring, Loop – Estimating Magnetic Field Fluctuations Near a Ferromagnet**

Russell W. Burgett,¹ John A. Marohn,¹ Robert D. McMichael²

1. Cornell University, Ithaca, NY 14850 2. National Institute of Standards and Technology, Gaithersburg, MD 20899

Detecting and measuring the dynamics of spins near a ferromagnet represents a key challenge in chemical physics. Many spin-based quantum computing proposals involve carrying out electron or proton (spin) magnetic resonance in close proximity to a magnet [1]. Moreover, nitrogen-vacancy (NV) center imaging and magnetic resonance force microscopy (MRFM) employ nanoscale magnets close to spins [2,3]. One potential problem in these experiments is loss of signal due to unwanted spin-lattice relaxation caused by stochastic magnetic field fluctuations [4]. We present a novel simulation protocol — ground, ping, ring, loop (GPRL) — to estimate thermomagnetic fluctuations of ferromagnets. Using NIST's object oriented micromagnetic framework (OOMMF) code, we apply a pulsed magnetic field at a point of interest, calculate the resulting transient change in magnetization at each location in the ferromagnet, and use a Fourier transform fluctuation-dissipation theorem relation to compute the power spectral density of field fluctuations at the point of interest. From this, we can estimate T1 of the sample spins and assess losses in signal expected for different magnetic materials (Co, Ni, PrFeB, NdFeB, SmCo). We anticipate that the insights provided by this model will lead to higher resolution spin imaging experiments and better designed quantum spintronic devices.

[1] Cerletti, Loss, et al. *Nanotechnology* (2005) 15: R57.

[2] Grinolds, Yacoby, et al. *Nature Nanotechnology* (2014) 9: 279-284.

[3] Degen, Rugar, et al. *PNAS* (2009) 106(5): 1313-1317.

[4] Stipe, Rugar, et al. *Phys. Rev. Lett.* (2001) 87: 277602.

EPR POSTER SESSION

Russell W Burgett, Cornell University, 902 Triphammer Rd, Ithaca, New York, 14850, United States

E-mail: rwb273@cornell.edu

206 **Spectral Simulation and Spin Quantitation for Nitroxide Radicals in Mouse Lungs at L-band**

Autumn Canny,¹ Hanan B. Elajaili,² Lukas B. Woodcock,¹ Tanden A. Hovey,¹ Eva S. Nozik,² Sandra S. Eaton,¹ Gareth R. Eaton¹

1. University of Denver, Department of Chemistry and Biochemistry, Denver, CO 80210

2. Pulmonary Critical Care Medicine, University of Colorado Anschutz Medical Campus, 12700 E. 19th Ave, B131, Aurora CO 80045

To analyze reactive oxygen species in models of acute respiratory distress syndrome we are imaging nitroxide spin probes in excised mouse lungs at L-band. The number of spins in the mouse lung is only about 10¹⁴ to 10¹⁵ so signal-to-noise is limited. We are modeling the spectra to extract intensity information. The g and hyperfine values for the nitroxides are known and these parameters can be used to distinguish signal from noise. A MatLab app has been built to analyze spectra and spectral slices in two-dimensional spectral-spatial images. A simulated spectrum is compared with the experimental data. The user selects three spectral regions that encompass the three nitroxide hyperfine lines. The amplitude of the simulated spectrum that matches the experimental spectrum is calculated using the EasySpin rescale function. Limiting the scaling to the windows centered on the peaks decreases the impact of noise on the scaling. The integral of the simulated spectrum, multiplied by the scaling factor, is proportional to the number of spins in the sample or slice from an image.

This work was supported by NIH RO1CA1262159 and R33 HL157907.

EPR POSTER SESSION

Autumn Canny, University of Denver, 2101 E. Wesley Ave., Denver, Colorado, 80210, United States
E-mail: Kit.Canny@du.edu

207 Recent Advancements in DEER Sensitivity for Site-Directed Cu(II) Spin Labels

Josh Casto,¹ Xiaowei Bogetti,¹ Zilri Hasanbasri,¹ Alysia Mandato,¹ Nicholas Moriglioni,¹ Hannah Hunter,¹ Sunil Saxena¹

1. University of Pittsburgh, Department of Chemistry, Pittsburgh, PA, 15213

Cu(II)-based spin labels are an incisive and versatile tool in EPR to elucidate biophysical dynamics and conformational changes pertinent to biomolecular function¹. However, since nitroxide concepts do not translate directly to Cu(II), acquiring high quality data can be non-intuitive for those unfamiliar. Specifically, the innate fast relaxation times and broad EPR absorption spectrum of Cu(II) can be a sensitivity limitation for pulsed dipolar spectroscopy distance measurements¹. On the other hand, the narrow distance distributions and simple chelation labeling offered by Cu(II)-based protein labels are advantageous. These attributes permit Cu(II) labels to obtain structural details inaccessible to common nitroxide labels. In this talk we showcase recent method development aimed to alleviate sensitivity obstacles to make Cu(II) measurements more user friendly and accessible to the broader biophysical community. We demonstrate that protein and solvent deuteration dramatically improves Cu(II) sensitivity and sustains the duration of the dipolar modulated signal to 32 μs ². Further, incorporating 200 MHz bandwidth frequency-swept shaped pulses generated by commercial instrumentation increases measurement sensitivity even further by probing a greater portion of the Cu(II) spectrum than monochromic pulses. Additionally, orientationally averaged distances can be obtained with only two measurements by employing strategic acquisition schemes^{4,5}. When these advances in Cu(II) method development are combined we observe dramatic improvements to sensitivity that enables rapid collection of orientationally averaged long-range measurements in under two hours and short-range distances in only minutes.

[1] Gamble Jarvi, A.; Bogetti, Xiaowei; Singewald, K.; Ghosh, S.; Saxena, Sunil *Acc. Chem. Res.* 2021, 54(6), 1481-1491.

[2] Casto, Josh; Mandato, Alysia; Saxena, Sunil; *J. Phys. Chem Lett.* 2021, 12(19) 4681-4685.

[3] Casto, Josh; Bogetti, Xiaowei; Hunter, H. R.; Hasanbasri, Zilri; Saxena, Sunil 2023, 349, 107413.

[4] Hasanbasri, Zilri; Moriglioni, N.; Saxena, Sunil *Phys. Chem. Chem. Phys.* 2023. [In Press]

[5] Bogetti, Xiaowei. Hasanbasri, Zilri. Hunter, H. R.; Saxena, Sunil *Phys. Chem. Chem. Phys.* 2022, 23, 14727.

EPR ORAL SESSION

Josh Casto, University of Pittsburgh, 6723 McPherson Blvd Apt 5, Pittsburgh, Pennsylvania, 15208, United States
Tel: 7245132413, E-mail: jac246@pitt.edu

208 EPR and DFT Studies of Iron, Cobalt, and Nickel Compounds That Feature a Phosphine-Substituted Bis(imino)pyridine Chelate

Marco Flores,¹ M. R. Mena,¹ J. H. Kim,² S. So,² H. Ben-Daat,¹ T. M. Porter,¹ C. Ghosh,¹ A. Sharma,¹ T. L. Groy,¹ M.H. Baik,² R. J. Trovitch¹

1. Arizona State University, School of Molecular Sciences, Tempe, AZ 85287

2. Korea Advanced Institute of Science and Technology, Department of Chemistry, Daejeon 34141, Republic of Korea

It was recently discovered that $(\text{Ph}_2\text{PPrPDI})\text{Mn}$ (PDI = pyridine diimine) exists as a superposition of low-spin Mn(II) that is supported by a PDI dianion and intermediate-spin Mn(II) that is antiferromagnetically coupled to a triplet PDI dianion, a finding that encouraged the synthesis and electronic structure valuation of late first row metal variants that feature the same chelate. The addition of Ph_2PPrPDI to FeBr_2 resulted in bromide dissociation and the formation of $[(\text{Ph}_2\text{PPrPDI})\text{FeBr}][\text{Br}]$. Reduction of this precursor using excess sodium amalgam afforded $(\text{Ph}_2\text{PPrPDI})\text{Fe}$, which possesses an Fe(II) center that is supported by a dianionic PDI ligand. Similarly, reduction of a premixed solution of Ph_2PPrPDI and CoCl_2 yielded the cobalt analog, $(\text{Ph}_2\text{PPrPDI})\text{Co}$. EPR spectroscopy and density functional theory calculations revealed that this compound features a high-spin Co(I) center that is antiferromagnetically coupled to a PDI radical anion. The addition of Ph_2PPrPDI to $\text{Ni}(\text{COD})_2$ resulted in ligand displacement and the formation of $(\text{Ph}_2\text{PPrPDI})\text{Ni}$, which was found to possess a pendent phosphine group. Single-crystal X-ray diffraction, CASSCF calculations, and EPR spectroscopy indicate that $(\text{Ph}_2\text{PPrPDI})\text{Ni}$ is best described as having a Ni(II)-PDI²⁻ configuration. The electronic differences between these compounds are highlighted, and a computational analysis of Ph_2PPrPDI denticity has revealed the thermodynamic penalties associated with phosphine dissociation from 5-coordinate $(\text{Ph}_2\text{PPrPDI})\text{Mn}$, $(\text{Ph}_2\text{PPrPDI})\text{Fe}$, and $(\text{Ph}_2\text{PPrPDI})\text{Co}$.

EPR POSTER SESSION

Marco Flores, Arizona State University, 1711 S Rural Rd, Tempe, Arizona, 85287-1604, United States
E-mail: mafloresr@asu.edu

209 Maximizing Modern CW EPR: Overmodulation via Regularization

Samantha M Betts, John M Franck

Syracuse University, Syracuse, NY

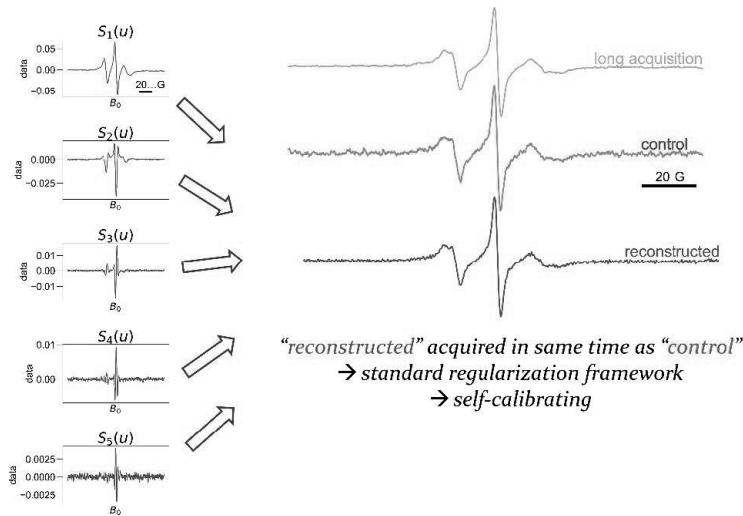

The deployment of digital lock in technology in many commercial EPR instruments has enabled broad improvements in cw ESR signal acquisition by routinely supporting the acquisition of multiple harmonics. Here, we present new schemes that improve the SNR of standard cw ESR and that facilitate detailed comparisons of cw ESR spectra. We demonstrate broad applicability by applying these schemes to spin-labeled transmembrane protein samples.

The well-documented mathematics of “pseudo-modulation”¹ predicts how ESR signal responds to over-modulation. The inverse problem of “over-modulation reconstruction” determines the derivative signal from a set of multiple harmonics acquired under over-modulated conditions. Previous research has developed general solutions to the over-modulation reconstruction problem. However, the state-of-the-solutions for ESR spectroscopy tend to rely on a complex formula derived from variational optimization, to require some form of calibration, and to require implementation of a frequency-domain filter in order to see gains in SNR^{2,3}.

As an alternative, this presentation will detail how the pseudomodulation math can be expressed as a simple linear algebra problem with a very sparse kernel, enabling Tikhonov Regularization to construct the derivative spectrum underlying a particular over-modulated multi-harmonic dataset. Crucially, we show that the least-squares solution (i.e. in the absence of regularization) corresponds exactly to the previously determined variational solution.

Notably, regularization obviates the need for a frequency-domain filter. Furthermore, the mathematics for reconstructing the result from several experiments acquired at several different modulation amplitudes becomes readily apparent. Perhaps most importantly, this technique obviates the need for calibrating the response of the individual harmonic channels.

We also briefly comment on a trivial method to construct a network graph showing the relationship between a large set of cw ESR spectra acquired on surfactant-solubilized cw ESR spectra in our lab.

[1] Nielsen RD, Hustedt EJ, Beth AH, Robinson BH. J Magn Reson. 2004 Oct;170(2):345–371. PMID: 15388099 doi:10.1016/j.jmr.2004.07.007.

[2] Tseitlin M, Eaton SS, Eaton GR. J Magn Reson. 2011 Apr;209(2):277–281. doi:10.1016/j.jmr.2011.01.027.

[3] Yu Z, Tseitlin M, Eaton SS, Eaton GR. J Magn Reson. Academic Press; 2015 May;254:86–92. doi:10.1016/j.jmr.2015.03.006.

EPR POSTER SESSION

John M Franck, Syracuse University, 111 College Pl, Syracuse, New York, 13211, United States

Tel: 3154433171, E-mail: jmfranck@syr.edu

210 Defining The Conformational Landscape Governing Ligand-Mediated $\beta 2$ Adrenergic Receptor Signaling Using Pressure Resolved Double Electron Electron Resonance (PRDEER) Spectroscopy

Alexander M. Garces,¹ Patrick C. Brennan,¹ Biswaranjan Pani PhD,² Robert J. Lefkowitz MD,² Michael T. Lerch Ph.D.¹

1. Medical College of Wisconsin, Department of Biophysics, Milwaukee, WI 53226

2. Duke University, Department of Medicine, Durham, NC 27710

The β -adrenergic receptors (β ARs) are a subfamily of G protein-coupled receptors (GPCRs) that are expressed by most cell types in humans, regulating a wide variety of physiological processes.¹ GPCRs are activated by binding

extracellular ligands. The activated GPCR then interacts with intracellular transducers, mediating downstream signaling events. During receptor signaling, a bound extracellular ligand causes the GPCR to undergo a conformational change, manipulating how the GPCR interacts with intracellular transducers. The ligand shifts the conformational equilibrium of the receptor toward active or inactive states, depending on whether it is an agonist, inverse agonist, or antagonist. The prevailing conformational selection model suggests that receptors exist as an ensemble of distinct conformations in dynamic equilibrium where each conformation translates functionally by possessing distinct affinities and catalytic activities for the different intracellular transducer proteins.² Experimental techniques that characterize structural differences of functionally distinct receptor conformations and their equilibrium populations are paramount in furthering our understanding of ligand-mediated GPCR signal transduction. Pressure induces a reversible shift in the conformational equilibria of the receptor, populating excited states that may otherwise be invisible, allowing for their characterization. With Pressure Resolved Double Electron-Electron Resonance (DEER), we can capture the relative populations of each conformation under different hydrostatic pressures. I have demonstrated a pressure dependence for different regions of the β 2-adrenergic receptor. These data indicate we can populate the active conformation of the β 2AR without a ligand, populating otherwise “invisible” portions of the conformational ensemble. In addition, we have also begun to explore how ligands manipulate the pressure induced conformational ensemble.

[1] Belmonte, S. L. & Blaxall, B. C. Conducting the G-protein coupled receptor (GPCR) signaling symphony in cardiovascular diseases: New therapeutic approaches. *Drug Discovery Today: Disease Models* vol. 9 Preprint at <https://doi.org/10.1016/j.ddmod.2012.03.001> (2012). 2. Lerch, M. et al. Viewing rare conformations of the β 2 adrenergic receptor with pressure-resolved DEER spectroscopy. 117, (2020).

EPR POSTER SESSION

Alexander M Garces, Medical College of Wisconsin, 8701 W Watertown Plank Rd, Milwaukee, Wisconsin, 53226, United States

E-mail: agarces@mcw.edu

211 Electron Paramagnetic Resonance of Actinide Coordination Complexes

Samuel M. Greer, Nikki J. Wolford, Thaige P. Gompa, Maksim Y. Livshits, and Benjamin W. Stein
Los Alamos National Laboratory, Los Alamos, New Mexico 87545, USA

Electron Paramagnetic Resonance (EPR) methods have been used extensively to unravel the origin of physical properties in transition metal coordination complexes. Despite this success few studies have applied EPR techniques to actinide-containing compounds. At the same time our understanding of bonding and the relationship between physical and electronic/magnetic properties in actinides remains anemic compared to the rest of the periodic table. Here, we present on our efforts using continuous wave- and pulse- EPR methods to probe the magnetic properties of actinide-based coordination complexes. We will also present our development of the Actinide Spectroscopy Laboratory housed at Los Alamos National Laboratories. These efforts span optical and magnetic characterization techniques equipped to handle the unique challenges posed by radiological materials. We have also established procedures for the study of actinide coordination complexes using the high-frequency/high-field EPR spectrometers at the National High Magnetic Field Laboratory in Tallahassee, Florida. This unique combination of capabilities forms a powerful approach for probing the interplay between spin-orbit coupling, the ligand field, and their combined influence on the magnetic properties of molecules.

EPR POSTER SESSION

Samuel M Greer, Los Alamos National Laboratory, Bikini Atoll Rd, Bldg, SM-30, Los Alamos, New Mexico, 87544, United States

E-mail: sgreer@lanl.gov

212 Characterization of Protein Conformational Exchange Kinetics Using Pressure-jump EPR

Julian D. Grosskopf¹, Christian Altenbach², Jason Sidabras¹, Jim Anderson¹, Richard Mett¹, Robert Strangeway¹, Jim Hyde¹, Wayne Hubbell², Michael T. Lerch¹

1. Department of Biophysics, Medical College of Wisconsin, Milwaukee, WI 53226

2. Department of Chemistry and Biochemistry and Jules Stein Eye Institute, University of California, Los Angeles, CA 90095

The intrinsically dynamic nature of proteins plays a well-established role in a multitude of processes from enzyme catalysis to signal transduction. Often, physiologically relevant conformational states are invisible to conventional spectroscopic methods under ambient conditions. The application of high hydrostatic pressure has allowed functional low-lying excited states to be populated and studied using methods such as EPR, NMR, and a variety of optical spectroscopies. Pressure-jump relaxation techniques utilize a rapid change in pressure to generate a non-equilibrium state, and the timescale of relaxation to the new equilibrium provides conformational exchange rates and activation volumes for the pathway under study. Here, we describe a complete high-pressure EPR system at Q-band that offers the ability to perform both static pressure and millisecond-timescale pressure jump experiments on biological systems including spin-labeled proteins. The use of fast electrically-controlled valves to trigger the pressure change enables jumps up and down to be performed at any pressure from atmospheric pressure up to the maximum pressure

capability of the system components (~3500 bar). To demonstrate the utility of the system, we characterize a local folding-unfolding equilibrium of T4 lysozyme in 2 M urea. Our results demonstrate the ability of the system to capture relaxation processes on the low millisecond timescale, enhanced system automation and signal averaging capabilities, as well as effectively describing thermodynamic and kinetic parameters of protein conformational exchange.

EPR POSTER SESSION

Julian D Grosskopf, Medical College of Wisconsin, 8701 Watertown Plank Rd, Milwaukee, Wisconsin, 53226, United States

Tel: 16083861944, E-mail: jgrosskopf@mcw.edu

213 **Optically Detected Magnetic Resonance on Optoelectronic Systems**

Jeannine Grüne^{1,2}, Alberto Privitera³, Vladimir Dyakonov², Alex Gilett¹, Andreas Sperlich²

1. Cavendish Laboratory, University of Cambridge, JJ Thomson Avenue, Cambridge, UK

2. Experimental Physics 6, University of Würzburg, Am Hubland, 97074 Würzburg, Germany

3. Clarendon Laboratory, University of Oxford, Parks Road, Oxford, UK

Optically detected magnetic resonance (ODMR) is a highly useful technique for organic semiconductors, as it allows detection of their occupied paramagnetic states. By combining electron paramagnetic resonance with optical detection, ODMR achieves remarkably high sensitivity. Thus, ODMR is able to detect all paramagnetic states coupled to luminescence, including minor pathways and low-polarization spin states. Continuous-wave (cw) ODMR is based on continuous optical/electrical excitation, allowing steady-state populations to be studied, comparable to real devices in optoelectronic applications. In addition, steady-state conditions can enhance spin polarization compared to pulsed techniques due to accumulation or unequal recombination rates. ODMR finds its application in various organic systems, such as organic photovoltaics (OPVs), organic light-emitting diodes (OLEDs), and organic systems for quantum information. ODMR is an excellent complementary method to EPR techniques such as trEPR and all-optical techniques as transient absorption to obtain a picture of all pathways in optoelectronic materials and devices.

EPR POSTER SESSION

Jeannine Grüne, University of Cambridge, JJ Thomson Ave, Cambridge, England, CB3 0HE, United Kingdom

E-mail: jg2082@cam.ac.uk

214 **A 'Model Kit' for Understanding Orientational Selectivity in Cu(II)-based Distance Measurements**

Zikri Hasanbasri¹, Xiaowei Bogetti¹, Hannah Hunter¹, Nicholas Moriglioni¹, Sunil Saxena¹

1. University of Pittsburgh, Department of Chemistry, Pittsburgh, PA 15213

Pulsed-Dipolar Spectroscopy techniques primarily probe the magnetic dipolar interactions between two spins. Techniques that probe short-range interactions (ref) can characterize the local environments of a spin, while techniques that focus on long-range interactions (ref) can provide structural constraints within a biomolecule. However, for many paramagnetic metals such as Cu(II), Co(III), Fe(II), etc., a single pulse with limited bandwidth selectively samples only a small subset of orientations of the spins. This phenomenon, dubbed orientational selectivity, can bias the dipolar signal in manners unique to each sample, making the interpretation of the data difficult. While analytical approximations and global fitting tools have been successful in accounting orientational selectivity, we lack the ability to dissect how orientational selectivity affects the dipolar signal between two spins for a given pulsed technique. Here, we highlight an approach to dissect orientational selectivity by generating an in-silico sample of a Cu(II)-labeled protein to evaluate Cu(II)-based Double Electron-Electron Resonance (DEER) experiments at Q-band frequencies^{1,2}. The in-silico sample allows the identification of Cu(II) spins excited by a specific pulse and the extraction of the dipolar signal for different experimental parameters. More importantly, the in-silico sample allows comprehensive exploration of different samples with various organizations of the two spins. With the direct observation of how the orientations of the spins contribute to the dipolar signal, we obtained optimal acquisition schemes to mitigate orientational effects and extract only the distance between two Cu(II) labels. Additionally, we show that this orientational-averaging scheme can be done with commercially available instrumentations. Finally, we experimentally validated the averaging scheme on three different protein samples. Overall, we showcase a new approach for dissecting orientational selectivity and designing optimal acquisition schemes adaptable to other rigid spin labels and pulsed techniques.

Supported by NSF BSF MCB-2006154

1. Bogetti, Hasanbasri, Hunter, Saxena, PCCP, 2022, 24, 14727-14739.

2. Hasanbasri, Moriglioni, Saxena, PCCP, 2023, DOI: 10.1039/d3cp00404.

EPR ORAL SESSION

Zikri Hasanbasri, University of Pittsburgh, 219 Parkman Ave, Pittsburgh, Pennsylvania, 15213, United States

Tel: 4062181186, E-mail: zih12@pitt.edu

215 Development of a Pre-Clinical 1 GHz EPR Imager

Tanden A. Hovey,¹ Lukas B. Woodcock,¹ Hanan B. Elajaili,² George A. Rinard,¹ Samuel DeGraw^{+ 1} Autumn Canny,¹ Joseph P. Y. Kao,³ Eva S. Nozik,² Sandra S. Eaton¹ and Gareth R. Eaton¹

1. Department of Chemistry and Biochemistry, University of Denver, Denver, CO 80208 USA

2. Pediatric Critical Care Medicine, University of Colorado Anschutz Medical Campus, 12700 E. 19th Ave., B131, Aurora CO 80045 USA

3. Center for Biomedical Engineering and Technology and Department of Physiology, University of Maryland School of Medicine, Baltimore, MD USA

Pre-clinical EPR studies require seeking a balance between signal to noise, which increases with increasing microwave frequency for a fixed sample size, and tissue penetration depth, which increases at lower microwave frequency. A 1 GHz spectrometer provides a reasonable balance. In vivo radical concentrations are inherently low, necessitating design for optimum sensitivity in preference to flexibility. A focus on in vivo measurement of nitroxide radicals favors rapid-scan EPR over CW and pulse EPR, so the design of the spectrometer/imager requires resonators and software to implement rapid magnetic field scans. Narrowing the focus from a general use system to a more specialized one has allowed for a variety of improvements over the previous version of the spectrometer [1], which was designed for maximum flexibility. We minimized the losses due to components in the signal detection path and achieved a lower noise figure by placing the first stage amplifier as close as feasible to the output of the resonator. A directional coupler can be used in place of a circulator with a reflection resonator to further lower the noise figure, but sometimes the higher power achievable with a circulator is needed. The noise figure of the detection path is now 6 compared to 11.2 for the

previous iteration [1]. In the process of testing various components, the best RF source, amplifiers, and detector setup were determined for this system. An important future step will be to determine how small the system can be and still achieve reasonable signal-to-noise. Supported by NIH RO1CA1262159 (GRE) and R33 HL157907 (ESN and SSE).

[1] L. A. Buchanan, G. A. Rinard, R. W. Quine, S. S. Eaton, and G. R. Eaton, Tabletop 700 MHz EPR Imaging Spectrometer, Concepts Magn. Reson. B, Magn. Reson. Eng. 48B, e21384, (2018), doi: 10.1002/cmr.b.21384.

EPR POSTER SESSION

Tanden Hovey, University of Denver, 2199 S. University Blvd., Denver, Colorado, 80208, United States

E-mail: tanden.hovey@du.edu

216 Overhauser DNP Solvent Dynamics Measurements of Binary Mixtures

Timothy J. Keller,¹ Yen-Chun Huang,¹ Thorsten Maly.¹

1. Bridge12 Technologies, Inc. Natick, MA.

Overhauser dynamic nuclear polarization (ODNP) is a technique capable of enhancing the nuclear spin polarization by on-resonance microwave irradiation of a paramagnetic polarizing agent. This technique requires the hyperfine coupling between an electron and nuclear spin to be modulated at frequencies close to the electron spin Larmor frequency. By measuring the enhancement of the NMR signal, one can probe the molecular dynamics at frequencies relevant to the rotational and translational diffusion of molecules. Recent instrumentation developments have enabled high-resolution ODNP measurements at low magnetic field.^{1,2} At a magnetic field of 0.35 T (15 MHz ¹H), we achieve linewidths of < 2.3 Hz (0.16 ppm) for a water sample with 200 μ M TEMPOL. The improvements in resolution introduce the possibility of performing site specific solvent dynamics measurements on mixtures to extract a more detailed understanding of molecular dynamics in these mixtures. As a model system, we use binary mixtures of water and acetonitrile. It has long been known that acetonitrile acts as a water structure “enhancer” that promotes water hydrogen bonds.³ Although water and acetonitrile are completely miscible on a macroscopic level, at the molecular level water prefers to hydrogen bond with water molecules. We show the enhancement of water and acetonitrile. Water consistently exhibits larger enhancements. We find that the molecular dynamics of water becomes slower as the amount of acetonitrile increases. This is contrary to the bulk viscosity which tends to decrease with increasing acetonitrile content. Our results are interpreted as acetonitrile acting as a water structure enhancer.

1. T.J. Keller, et al. J. Magn. Reson. 313 (2020): 106719.

2. T.J. Keller, et al. Magn. Reson. 2 (2021): 117–28.

3. H. Kovacs, et al. J. Am. Chem. Soc. 113 (July 1991): 5596–5605.

EPR POSTER SESSION

Timothy Keller, Bridge12 Technologies, Inc, 11 Michigan Dr., Natick, Massachusetts, 01760, United States

Tel: 6514706101, E-mail: tkeller@bridge12.com

217 **A Novel Simulation Strategy Facilitates the Design of Resonator Coupling -- An Application to ODNP**

Warren F. Kincaid,¹ John M. Franck¹

I. Syracuse University, Department of Chemistry, Syracuse, NY, 13244

Instrumentation for liquid state Overhauser Dynamic Nuclear Polarization currently relies on the integration of an NMR coil within an ESR cavity. At X-band, the typical hairpin loop coil prevents perturbation of the cavity fields, but with a low-filling factor and weaker sensitivity than desired. This presents the challenge of incorporating a solenoid NMR probe for a greater NMR filling factor and sensitivity, while maintaining a large sample size and minimal sample heating. Here we present a unique protocol for the design of a coupled resonator cavity using an eigenmode simulation strategy. This protocol provides the opportunity to investigate new coupling schemes, to facilitate a more intuitive optimization of a coupled resonator design compared to other simulation methods, and to display unobscured evanescent fields in the process. It also demonstrates how first order resonant mode mixing can explain imperfections to the desired resonator cavity mode. With the opportunity to investigate a larger solenoid probe and its field perturbations, we can optimize the probe's integration within a rectangular ESR cavity. This has great significance as the design requires both the implementation of an unusual coupling design, as well as the avoidance of significant heating and shielding effects brought on by the incorporation of the solenoid NMR probe.

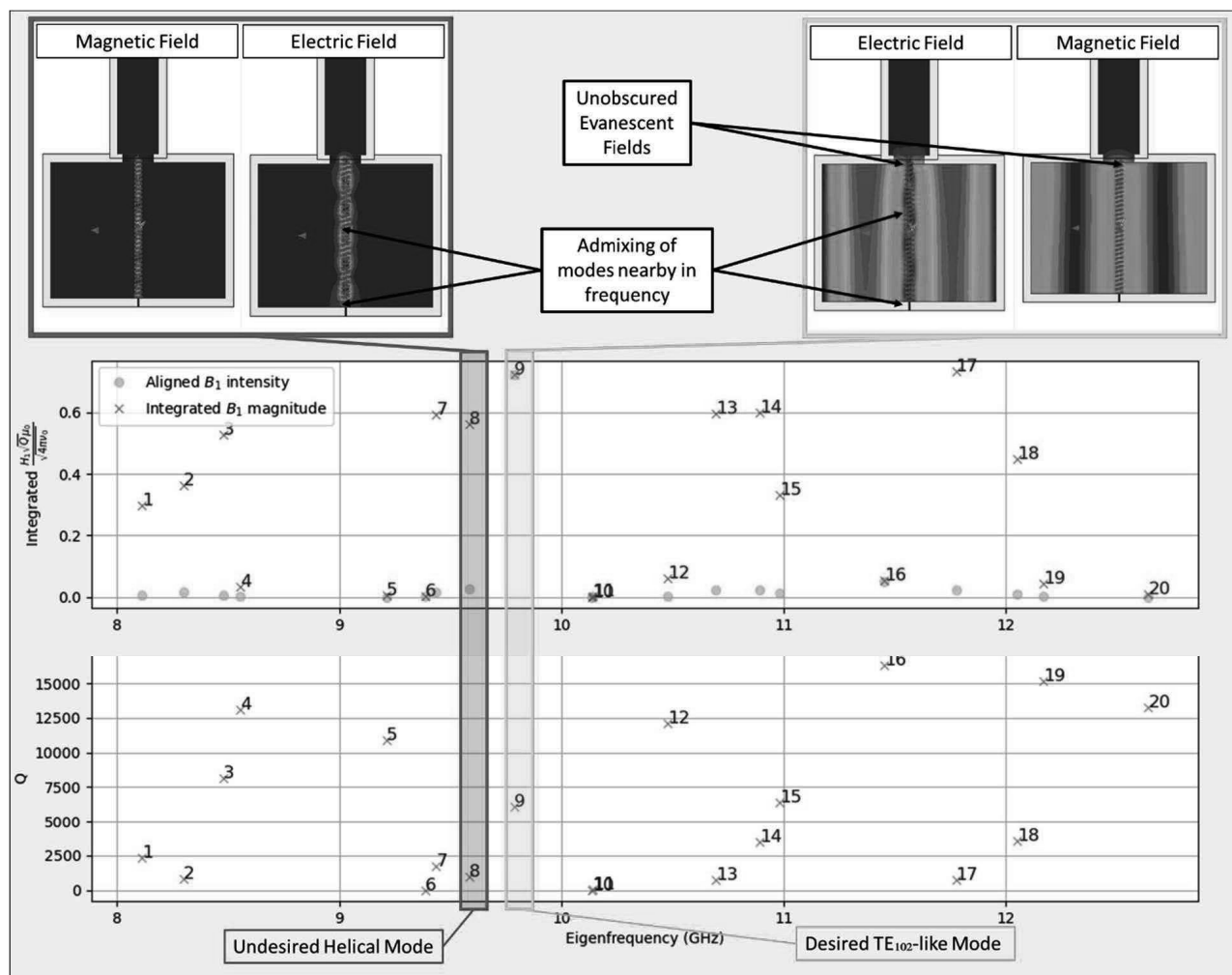

EPR POSTER SESSION

Warren F Kincaid, Syracuse University, 459 Westcott St., Syracuse, New York, 13210, United States

Tel: (315) 443-1778, E-mail: wfkincai@syr.edu

218 **The Control of Catalytic Reactivity in [FeFe]-hydrogenases Examined Through Multifrequency CW and Pulse EPR**

Effie C. Kisgeropoulos, Jacob H. Artz, David W. Mulder, and Paul W. King

Biosciences Center, National Renewable Energy Laboratory, Golden, Colorado 80401

[FeFe]-hydrogenases catalyze the reversible activation of H₂ at the H-cluster, which is composed of a [4Fe-4S] cluster coordinated by a cysteine thiolate to an organometallic 2Fe-2S subsite. These enzymes can also utilize accessory FeS

clusters (F-clusters) to function as electron relays, transferring electrons to or from the H-cluster during catalysis. Studies of [FeFe]-hydrogenases have revealed an impressive 10^7 -fold range in reactivity bias, i.e., the preference for H_2 oxidation vs. H^+ reduction. However, a majority of the enzymes that have been studied fall within a narrow window of this range and a full understanding of the properties that control catalytic bias remains an open question. Insights can be gained from studying enzymes that exemplify the boundaries of reactivity bias, and one such example is the [FeFe]-hydrogenase II from *Clostridium*

pasteurianum (CpII). CpII exhibits an unusually strong preference for H_2 oxidation, with a 104-fold greater k_{cat} than for H^+ reduction reaction. We have been utilizing potentiometric IR and EPR, as well as multifrequency CW and pulse EPR, to understand the properties of CpII that enable H_2 oxidation. The results are leading to insights on the H-cluster catalytic intermediates and the biophysical properties of F-clusters relevant to electron transfer. The outcome of these studies is interpreted in a model that proposes a functional basis for the H_2 oxidation bias of the CpII H-cluster. We also describe a mechanistic foundation for highly directional electron transfer in CpII that results from a combination of spin-spin coupling and thermodynamic landscape of the F-cluster system. These findings inform on mechanisms of directional control over oxidation and reduction reactivity in biological systems, with broad applications to multi-electron redox-catalysis.

EPR POSTER SESSION

Effie C Kisgeropoulos, National Renewable Energy Laboratory, 2507 Zenobia St, Denver, Colorado, 80212, United States
Tel: 3303650417, E-mail: ekisgero@gmail.com

219 Assessment of Blood-Brain-Barrier Leakage and Brain Oxygenation in Connexin-32 Knockout Mice with Systemic Neuroinflammation Using EPR Imaging

Navin Viswakarma,¹ Safa Hameed,¹ Mona Freidin,² Boris Epel,^{1,3} Charles Abrams² and Mrignayani Kotecha^{1*}

1. Oxygen Measurement Core, O2M Technologies, LLC, 2201 W Campbell Park Dr., Chicago, IL 60612, USA

2. Department of Neurology and Rehabilitation, University of Illinois at Chicago, Chicago, IL 60612, USA

3. Department of Radiation and Cellular Oncology, The University of Chicago, Chicago, IL 60637, USA.

Neuroinflammation is one of the main mechanisms involved in the progression of neurodegenerative diseases, leading to progressive loss of brain functions. One of the key characteristics of neurodegenerative diseases is damage to the blood-brain barrier (BBB). This proof-of-concept study aimed to assess the ability of trityl OX071-based electron paramagnetic resonance imaging (EPRI) to observe the leakage in BBB and provide partial oxygen pressure (pO₂) maps in the neuroinflammatory-induced mouse brain.

Five Cx32-knockout mice were injected with lipopolysaccharide (LPS) to induce neuroinflammation. The change in the animals' posture and hunching suggested the disease progression with time. The EPRI imaging was performed using a preclinical EPRI instrument, JIVA-25™, at time $t = 0$ -, 4-, and 6-hours post-injection with systemic injection of the spin-probe trityl OX071 at each time point. Two imaging sequences were utilized, inversion recovery electron spin echo (IRESE) for obtaining pO₂ maps and single point imaging (SPI) for obtaining spatial maps. The contrast in amplitude images was used for outlining the brain cavity and confirmation of BBB leakage by the spin probe.

It was believed earlier that the trityl spin probe does not enter healthy animals' brains. However, we observed small leakage in the brain region in amplitude maps. This allowed us to map the brain without having the external MRI maps and also get the pO₂ maps of the brain because of the high sensitivity of JIVA-25™. An increase in EPRI image signal intensity from brain regions was observed for all five animals as a function of time indicating the increased leakage of BBB in these animals with the disease progression. With the disease progression, pO₂ in the brain region decreased leading to hypoxia in some cases. For the first time, we show the ability of EPRI to observe the disruption of BBB along with providing pO₂ maps in the neuroinflammatory mice. We expect that this study will open new avenues to noninvasively image and understanding of the pathology of neurodegenerative disease progression and provide a path to new treatments.

EPR POSTER SESSION

Mrignayani Kotecha, O2M Technologies, LLC, 2201 W Campbell Park Dr., STE 310, Chicago, Illinois, 60612, United States

E-mail: mkotecha@o2map.com Contact: mkotecha@oxygenimaging.com

220 Characterization of Mn²⁺-substituted Cyclic GMP-AMP Synthase (cGAS)

Elizabeth R. Flood, Lydia A. Hubbard, Parker A. Tamucci, Eleanor J. Todd, Emma G. Wasden, Molly M. Lockart
Department of Chemistry and Biochemistry, Samford University, 800 Lakeshore Drive, Birmingham, AL 35229, United States

In mammals, one of the key pathways involved in foreign DNA recognition and host cell defense is mediated by cyclic guanosine monophosphate-adenosine monophosphate synthase (cGAS), a member of the nucleotidyltransferase (NTase) superfamily. cGAS binds double-stranded DNA in the cytosol, which can be present in the case of viral or bacterial infections or DNA damage. Upon binding dsDNA, cGAS catalyzes the production of cyclic GMP-AMP

(cGAMP), a second messenger that activates the stimulator of interferon genes (STING) pathway, eventually leading to cytokine production. Like many Ntase enzymes, cGAS uses Mg^{2+} as its catalytic cofactor. However, recent studies have shown that Mn^{2+} also directly activates the enzyme, leading to a novel cGAMP synthesis. Interestingly, Mn^{2+} has a potential role in the broader immune system. Previous work has shown that it is released into the cytosol in response to viral infections and that Mn^{2+} -deficient mice have impaired antiviral function. Despite evidence for a role of Mn^{2+} in the innate immune response, open questions remain about its impact on catalytic function in cGAS. This work focuses on characterizing Mn^{2+} -substituted cGAS using fluorescence polarization measurements and electron paramagnetic resonance (EPR) spectroscopy. A more in-depth understanding of how Mn^{2+} activates cGAS will not only provide new insight into cGAS-mediated antiviral responses, but it will also further our understanding of the role of Mn^{2+} in the human immune response.

EPR POSTER SESSION

Molly M Lockart, Samford University, 800 Lakeshore Drive, Birmingham, Alabama, 35229, United States
Tel: 2057262680, E-mail: mlockart@samford.edu

221 Impact of Metal-Organic Framework (MOF) Crystallinity on Enzyme Orientation and Dynamics

Austin L. MacRae,¹ Zoe J. Armstrong,¹ and Zhongyu Yang¹

1. North Dakota State University, Department of Chemistry and Biochemistry, Fargo, ND 58108-6050

Enzyme encapsulation in Metal-Organic Frameworks (MOFs) can be challenging for large enzymes, large substrate enzymes, and enzyme clusters. Co-crystallization of MOFs in aqueous solution is a unique way to overcome this challenge, but the crystallinity of co-crystallized MOFs can be reduced. This drawback of co-crystallization raises concerns on how enzyme performance is impacted by the packing quality of these MOFs. In this work, we expand on recent discoveries of multiple aqueous-phase co-crystallized MOFs is being further investigated utilizing site-directed spin labeling (SDSL) – Electron Paramagnetic Resonance (EPR) spectroscopy to probe enzyme dynamics and restriction.¹ This technique probes protein backbone motions, which are directly related to the local crystal packing quality and density. A rough connection between protein mobility/dynamics and MOF crystallinity was found through the EPR studies and simulations. This work suggests a connection between MOF crystal packing/density and protein mobility that could guide future design of materials for enzyme immobilization.

[1] Jordahl et al., ACS Appl. Mater. Interfaces., 2022, 14(46), 51619-51629.

EPR POSTER SESSION

Austin L. MacRae, North Dakota State University, 1334 9th Ave N, Apt 12, Fargo, North Dakota, 58102, United States
E-mail: austin.macrae@ndsu.edu

222 Improving Sensitivity of Distance Measurements at Nanomolar Protein Concentrations using Double Quantum Coherence

Alysia Mandato,¹ Zikri Hasanbasri,¹ and Sunil Saxena¹

1. University of Pittsburgh, Department of Chemistry, Pittsburgh, PA 15213

Recently, there have been remarkable improvements in pulsed EPR sensitivity. Solvent and cryoprotectant deuteration have prolonged phase memory times of samples, cryogenic amplifiers have decreased measurement times, and spectrometers with low-noise microwave amplifiers have resulted in relaxation measurements of only 10^7 spins.¹⁻³ These achievements are paving the way for a broader applicability of EPR in measuring biological distance constraints, for instance, at physiological concentrations and for more complex systems. Nonetheless, there remains a need for rapid and reliable methods of measuring distances between spins at nanomolar concentrations. Currently, nanomolar distance measurements with the commonly used

nitroxide spin label take multiple days using double electron-electron resonance (DEER) spectroscopy. In this work, we demonstrate the sensitivity of double quantum coherence (DQC) experiments at Q-band frequencies. We achieve highly sensitive distance measurements at nanomolar protein concentrations with DQC in significantly less time as compared to DEER. Additionally, we observe improved signal modulations, which open up new applications for distance measurements. We anticipate nanomolar concentration measurements will lead to further advancements in sensitivity, especially in in-cell contexts.

Supported by NSF BSF MCB-2006154.

1. Casto et al., Phys. Chem. Lett., 2021, 12, 4681.
2. Kalendra et al., Magn. Reson., 2023, 346, 107356.
3. Isaev et al., Magn. Reson. Open, 2023, 14-15, 100092.
4. Hasanbasri, et al., Chem. Chem. Phys., 2023.

EPR ORAL SESSION

Alysia Mandato, University of Pittsburgh, 219 Parkman Ave, Pittsburgh, Pennsylvania, 15213, United States

223 The Landau-Zener-Stückelberg-Majorana Transition in the $T_2 \ll T_1$ Limit

Michael C. Boucher¹, Peter Sun¹, Lee E. Harrell², and John A. Marohn¹

1. Cornell University, Ithaca, NY 14850

2. U.S Military Academy, West Point, NY 10996

Landau-Zener-Stückelberg-Majorana (LZSM) transitions occur between quantum states when parameters in the system's Hamiltonian are varied continuously and rapidly. In magnetic resonance, losses in adiabatic rapid passage (ARP) can be understood using the physics of LZSM transitions. When studying magnetic resonance, we all learn that magnetization fails to follow the effective field if the magnetic field or irradiation frequency is swept too fast. The LZSM treatment gives a closed-form result for the final magnetization in an ARP experiment as a function of sweep rate, valid in the limit of infinitely long relaxation times. Most treatments of LZSM transitions ignore the T_2 dephasing of coherences. Motivated by ongoing work in magnetic resonance force microscopy, we employ the Bloch equations, coordinate transformations, and the Magnus expansion to derive expressions for the final magnetization following a rapid field sweep at fixed irradiation intensity that include T_2 losses. Our derivation introduces an inversion-function, Fourier transform method for numerically evaluating highly oscillatory integrals. Expressions for the final magnetization are given for low and high irradiation intensity, valid in the $T_2 \ll T_1$ limit. Analytical results are compared to numerical simulations. Our relatively straightforward calculation reproduces semiquantitatively the well known LZSM result in the $T_2 \rightarrow 0$ limit. Our results can be used to pick an optimal B_1 in a force-gradient magnetic resonance force microscopy experiment. Supported by NIH R01GM143556.

EPR POSTER SESSION

John A Marohn, Cornell University, 150 Baker Laboratory, Dept. of Chemistry and Chemical Biology, Ithaca, New York, 14853-1301, United States

Tel: 607-255-2004, E-mail: jam99@cornell.edu

224 Investigating Role of Nuclear Spin Patterning and Counterion on Spin Relaxation in V(IV) Complexes

Roxanna Martinez,¹ Cassidy E. Jackson,¹ Ökten Üngör,¹ Johan van Tol,² and Joseph M. Zadrozny.¹

1. Colorado State University, Department of Chemistry, Fort Collins, CO, 80523

2. National High Magnetic Field Laboratory, Tallahassee, FL 32310

Molecular complexes are promising candidates for spin applications spanning from magnetic resonance imaging to quantum information processing.^{1,2} A key challenge in advancing these applications is fundamentally understanding how to generate long electron spin relaxation times (T_1 , T_m) in magnetic environments. A major problem to this challenge is the presence of other magnetic nuclei in the environment. The presence of these nuclei causes the shortening of spin relaxation times, which is not ideal for applications.³ To address this issue, we study the role of the nuclei in the ligand shell and counterions on relaxation.^{4,5} We take a synthetic approach at exploring the role of the ligand-based nuclei on a series of Vanadium (IV) complexes via nuclear spin patterning studies with varying arrangements of ¹H, ²H, ¹⁹F, ^{35/37}Cl, and ^{79/81}Br substitution on the ligand backbone and R₃NH₊ counterions (R = Et, n-Bu, n-Hex). We report high-field, high frequency pulsed electronic paramagnetic resonance (EPR) spectroscopy data to analyze the effect of the ligands nuclear spin patterning and the counterion on the electronic spin of the metal.

Supported by the National Science Foundation (CAREER award 1465954) and Research Corporation for Scientific Advancement (Cottrell Scholar award 5303391).

[1] R. Wasielewski et. al., Nat. Rev. Chem., 2020, 4, 490–504.

[2] K. P. Malikidogo et. al., Pharm., 2020, 13, 436.

[3] S. Eaton et. al., Biomedical EPR. Part A, Free radicals, Metals, Medicine and Physiology, Springer, 2011.

[4] C-Y. Lin et. al., Chem. Sci., 2019, 10, 548–555.

[5] C. E. Jackson et. al., Chem. Sci., 2019, 10, 8447–8454.

EPR POSTER SESSION

Roxanna Martinez, Colorado State University, 502 W Myrtle St, Fort Collins, Colorado, 80521, United States

Tel: 2108278470, E-mail: roxanna.martinez@colostate.edu

225 A Versatile Setup for FTIR Spectroscopy in High Magnetic Fields

Dubnická Midlíková^{1*}, M. Šedivý¹, A. Sojka^{1,2}, V. Tadeu Santana¹, Adam Dubroka^{1,3}, Petr Neugebauer¹

1. CEITEC—Central European Institute of Technology, Brno University of Technology, Purkyňova 123, 61200 Brno, Czech Republic

2. ITST - Institute of Terahertz Science and Technology, University of California, Santa Barbara, CA 93106-4170 3.

3. Masaryk University, Faculty of Science, Kotlářská 267/2, 61137 Brno, Czech Republic

Fourier-transform infrared (FTIR) spectroscopy in high magnetic fields or simply FTIR magneto-spectroscopy is a powerful spectroscopic technique used to investigate many important effects in materials, e.g., electron spin resonance,

cyclotron resonance, and transitions between Landau levels. Despite their enormous potential in solid-state physics, infrared magneto-spectrometers are still relatively rare. We present a versatile FTIR magneto-spectroscopic setup operating in the range of 5 – 10,000 cm⁻¹, high magnetic field up to 16 T and temperatures between 2-320 K. This setup allows us to perform a variety of magneto-optical measurements spanning the range from THz/far-infrared (FIR) to near-infrared (NIR). It consists of a commercial FTIR spectrometer coupled to a 16 T cryogen-free superconductive magnet by the custom-designed optical coupling and transmission probes designed for experiments with various detectors and samples in Faraday geometry. The functionality of the FTIR magneto-spectroscopic setup is demonstrated by the magneto-optical measurements on a cobalt-based single-molecule magnet (SMMs) in the FIR region and germanium in the NIR region. For the investigation of SMMs, spectroscopic techniques, such as EPR spectroscopy, are essential due to their ability to probe molecular and electronic properties directly. However, because of systems with large zero-field splitting, FTIR spectroscopy in the high magnetic field is needed to access fundamental transitions in SMMs. This setup¹ allows studying the EPR of SMMs with very large zero-field splitting, mainly based on transition metal complexes² or lanthanides³ that standard EPR systems cannot study since they do not provide experimental access to the magnetic resonance transitions. Besides, the FTIR magneto-spectroscopic setup can probe band structure and elucidate electronic properties of semiconductors, such as germanium, and novel 2D materials, such as graphene⁴.

[1] Dubnická Midlíková et al., IEEE Trans. Inst. & Meas. 2023, under review.

[2] J. Juráková et al., Inorganic Chemistry Frontiers 2022, 9.

[3] R. Marx et al., Chemical Science 2014, 5, 8.

[4] M. Orlita et al., Physical Review Letters 2008, 101, 267601.

EPR POSTER SESSION

Petr Neugebauer, Central European Institute of Technology, Brno University of Technology, Purkynova 123, Brno, Jihomoravsky kraj, 61200, Czech Republic
E-mail: petr.neugebauer@ceitec.vutbr.cz

226 Spin-Correlated Radical Pairs in Quantum Dot–Organic Molecule Conjugates

Jens Niklas,¹ Oleg G. Poluektov,¹ Mandefro Y. Teferi,¹ Autumn Y. Lee,² Jacob H. Olshansky.²

1. Argonne National Laboratory, Chemical Sciences and Engineering Division, Lemont, IL 60439

2. Amherst College, Department of Chemistry, Amherst, MA 01002

Photochemical charge separation in organic donor-acceptor systems and natural photosynthetic reaction center proteins can result in formation of spin-correlated radical pairs (SCRPs). These SCRPs exhibit peculiar properties, among them a strong spin polarization, deviating strongly from thermal equilibrium without requiring ultralow temperatures. Recently, the SCRPs have attracted attention in the fields of quantum sensing and quantum computation, since the electron spins that compose the radical anion and radical cation pair represent a qubit pair with four accessible states, and initially only two of those states are populated. The spin states of these systems can be probed and manipulated with microwave pulses using electron paramagnetic resonance (EPR) techniques. In contrast to the more well-studied organic donor-acceptor systems, there are very few electron spin measurements of photogenerated spin correlated-radical pairs in inorganic photocatalytic systems. Here we focus on semiconducting ZnO quantum dots (QDs) connected with organic dye molecules. The QDs offer a flexible platform for studying spin qubit pairs owing to both their size tunable electronic and spin properties as well as their surface functionality. The spin states in QDs can have g-values far from the 1.99-2.01 range common to organic molecules. This enables more straightforward spin specific addressability than can be achieved with fully organic systems, thus satisfying a key requirement of functional qubit systems, and opens the door to a new class of promising qubit materials.

EPR POSTER SESSION

Jens Niklas, Argonne National Laboratory, 9700 S. Cass Ave, Lemont, Illinois, 60439, United States
Tel: 6302523547, E-mail: jniklas@anl.gov

227 The Loop-zag Resonator: A Loop-gap Resonator Design for Improved Sensitivity in Electron-spin Resonance Experiments

Brendan C. Sheehan,^{1,2} Guanchu Chen,^{1,2} Sai Chauhan,¹ Rilla McKeegan,¹ William Henshon,¹ Charles A. Collett,^{1,3} Francisca Abdo Arias,¹ Jonathan R. Friedman¹

1. Amherst College, Department of Physics & Astronomy, Amherst, MA 01002-5000

2. University of Massachusetts Amherst, Amherst, MA 01003-9305

3. Department of Physics, Muhlenberg College, Allentown, PA 18104

Loop-gap resonators (LGRs) have been used for years as a means of performing electron-spin resonance; LGRs can be modeled as a lumped-circuit device with resonant frequency $\omega = (LC)^{-1/2}$. The inductance L and capacitance C depend largely on the geometry of the loop and gap, respectively; the resonant frequency can be controlled via tuning of the loop radius, gap length, and gap width¹. For samples with sizes much smaller than the loop diameter, however, a standard loop-gap resonator design has an unacceptably small sample filling factor and signal-to-noise ratio for many spectroscopic applications. We present a novel loop-gap resonator design, the “loop-zag” resonator (LZR), as a practical solution to these issues². “Zags” in the resonator’s gap provide a dramatically increased gap length, replacing the LGR’s

parallel-plate gap capacitor with an interdigitated capacitor. To retain the original resonant frequency the loop radius is shrunk, resulting in an increased filling factor and a larger sample response. An increased number of zags therefore allows for an even smaller loop. Simulations demonstrate an improved B1 field strength in the loop of the LZR as compared to the LGR. We characterize the sensitivity of several LZR designs by measuring the cw spectrum of the ESR standard DPPH. We find the signal size increases with the number of zags.

- [1] Rinard and Eaton, In Biomedical EPR, Part B: Methodology, Instrumentation, and Dynamics, **2005**, 19–52.
[2] Friedman, Patent no. US 11,171,400 B2, issued **2021**.

EPR POSTER SESSION

Brendan Sheehan, Amherst College Physics Department, University of Massachusetts Amherst, 25 East Drive, Amherst, Massachusetts, 01002-5000, United States
Tel: 9148865750, E-mail: bcsheehan@umass.edu

228 Characterization of Free Radical Intermediates Generated by Nanoparticle Additives to Oil-based Lubricants

Julie Matheny, Roshan Rana, Phil Bankaitis, and Tatyana I. Smirnova
North Carolina State University, Raleigh NC

Petroleum-based hydrocarbon mixtures are the most common type of lubricants today. Recently, nano-lubricant additives demonstrated a great potential in improving tribological and thermophysical properties of oils. While major efforts have been directed towards uncovering the lubrication mechanisms and developing the best performing nano-additives, the roles these nanomaterials may play in degradation of the base oils were largely ignored. Currently, there is a dearth of understanding regarding effects of these nanomaterials on complex chain of radical-driven reactions associated with the oil degradation.

We report on spin trapping Electron Paramagnetic Resonance (EPR) to quantify production and characterize the chemical nature of short-lived free radicals produced in lubricants in presence and absence of titanium oxide nanoparticles (NPs) upon photoactivation. Using alpha-phenyl N-tertiary-butyl nitron (PBN) we have demonstrated that presence of 5 nm TiO₂ nanoparticles results in a significant increase of radical production in light oil (LO) upon an exposure to 365 nm light. Radical production increases with the increase in the illumination time. Alkoxy radical adducts were identified as the major and alkyl adducts as the minor components of the spectra with a signal from PBN-ox also present in some samples. Both alkoxy and alkyl adducts spectra show significant effects of rotational motion (broadening of the high field hyperfine components), not observed for the smaller PBN-ox molecule. This is consistent with both adducts having much higher molecular weights than PBN-ox and originating from the base oil. Removal of molecular oxygen from the base oil by bubbling dry Argon gas through the sample before the light exposure resulted in significant increase in signal intensity suggesting that molecular oxygen directly participates in free radical reactions. Additionally, we observed a loss of spectral resolution in deoxygenated samples. This could be attributed to generation of multiple spin adducts with overlapping spectra.

This work was supported by ACS PRF 65503-ND4 grant to TIS.

EPR POSTER SESSION

Tatyana I Smirnova, North Carolina State University, 2620 Yarbrough Dr, Raleigh, North Carolina, 27606-8951, United States
Tel: 9195134375, E-mail: ts210963@gmail.com

229 Investigating Methyl-driven Electron Spin Decoherence

Samuel M. Jahn, Rachele Stowell, Stefan Stoll
Department of Chemistry, University of Washington, Seattle, WA, United States

In EPR samples at cryogenic temperatures, most motional degrees of freedom are frozen out; however, methyl rotors are an important and common exception. A methyl group's low moment of inertia allows for a quantum tunneling mechanism that mixes spatially localized torsional states; from a spin perspective this provides another flip-flop mechanism that can contribute to electron spin decoherence. Understanding how methyl rotors influence electron spin coherence lifetime is important because of the ubiquity of methyl groups, from proteins to molecular qubits. Here we present our investigation on how methyl groups affect electron spin decoherence of TEMPO in both a methyl-free and a methyl-containing glassy matrix. We interpret the experimental results using numerical simulations that allow us to investigate the spatial dependence of individual methyl contributions.

EPR POSTER SESSION

Stefan Stoll, University of Washington, Department of Chemistry, Box 351700, Seattle, Washington, 98195, United States
Tel: 2065432906, E-mail: stst@uw.edu

230 Spectroscopic Investigation of Mn(II)-Dependent Enzyme from Rhodospirillum rubrum

Rachelle Stowell,¹ David Langelaan,² Jennifer Shepherd,³ Stefan Stoll¹

1. University of Washington - Seattle, Department of Chemistry, Seattle, WA 98195

2. Dalhousie University, Department of Chemistry and Biochemistry, Halifax, Nova Scotia, Canada B3H 4R2

3. Gonzaga University, Department of Chemistry and Biochemistry, Spokane, WA 99258

RquA is a bacterial enzyme involved in the biosynthesis of rhodoquinone (RQ), which is used as an electron carrier for ATP production under anoxic conditions.¹ Ubiquinone (UQ) is converted to rhodoquinone through the substitution of a methoxy group with an amino group. The amino donor for this reaction is S-adenosyl-L-methionine (SAM)[2]. While SAM is a common substrate used by radical SAM enzymes to form the 5'-deoxyadenosyl radical, the use of SAM as an amino donor is atypical. RquA requires Mn(II) as a cofactor to produce RQ.² In this work, both continuous wave and pulse electronic paramagnetic resonance (EPR) are used to study this Mn(II) center. X-band CW data reveals the presence of Mn(II) bound to RquA. High frequency CW EPR shows there are two distinct Mn(II) species present with zero-field splitting values of approximately 550 MHz and 2,000 MHz. These values suggest that both Mn(II) centers exhibit octahedral coordination geometry. 14N hyperfine sublevel correlation spectroscopy (HYSCORE) indicates the coordination of nitrogenous ligands. These results provide insight to how Mn(II) may play a role in catalysing the conversion of ubiquinone to rhodoquinone.

[1] AC Bernert et al. *Biochem Biophys Acta Mol Cell Biol Lipids* **2019** 1864, 1226-1234.

[2] T Neputane et al. *Comm Chem* **2022** 5, 1-13.

EPR POSTER SESSION

Rachelle K Stowell, University of Washington, Seattle, 4000 15th Ave NE, Seattle, Washington, 98195, United States

E-mail: stowell9@uw.edu

231 A High-Volume Resonator for Continuous Flow Dynamic Nuclear Polarisation

Daniel J. Sung, Robert I. Hunter, Graham M. Smith.

School of Physics and Astronomy, University of St Andrews, St Andrews, KY169SS, Scotland.

This poster describes the current state of development of a high-volume continuous flow resonator for EPR and Overhauser dynamic nuclear polarisation (ODNP) in aqueous samples. Over the last two decades the applications of ODNP have expanded to include hydration water dynamics on the surfaces of proteins¹, the production of pure water MRI contrast agents² and in-line liquid state NMR³. In these applications, the ability to produce a continuous flow of hyperpolarised solution is often desirable and an increase in polarised volume flow rate could further widen the scope of ODNP. So far, the maximum volume flow rates achieved have been limited to 4 mL/min and are often considerably less. This is in part due to the very large dielectric losses incurred as the volume of aqueous sample inside the resonator increases. The resonator described here features a novel cavity structure specifically designed to reduce dielectric losses and can hold up to 1mL of liquid sample. The EPR sensitivity of the resonator (filling factor x unloaded quality factor) is already comparable to commercially available alternatives, with further improvements predicted. Significant DNP enhancements are predicted by electromagnetic modelling and volume flow rates of 30 mL/min have already been demonstrated. This represents an order of magnitude increase in volume flow rate when compared to existing continuous flow DNP systems and would make the technique applicable to clinical MRI for the first time.

[1] Armstrong and Han, *Journal of the American Chemical Society*, **2009**, 131 (13).

[2] Fedotov et al., *Magnetic Resonance*, **2020**, 1.

[3] Kircher, Hasse and Münnemann, *Analytical Chemistry*, **2021** 93 (25).

EPR POSTER SESSION

Daniel J Sung, University of St Andrews, School of Physics and Astronomy, North Haugh, St Andrews, Scotland, KY169SS, United Kingdom

E-mail: ds222@st-andrews.ac.uk

232 HiPER - A High Sensitivity AWG EPR/DNP Spectrometer

Daniel Sung, Yujie Zhao, Paul Cruickshank, Hassane El Mkami, Robert Hunter, Graham Smith

School of Physics and Astronomy, University of St Andrews, Scotland

One of the major research goals of modern EPR is characterising the structure, function and molecular dynamics of large macro-molecular systems at natural concentrations in their native environment. The underlying technical requirements are often associated with the need for increased concentration sensitivity combined with high time resolution and broad instantaneous bandwidth.

HiPER is a quasi-optical induction-mode 94 GHz EPR/DNP spectrometer that operates in non-resonant mode with relatively large sample volumes. An advanced arbitrary waveform generator (AWG) gives full amplitude and phase control of the EPR excitation over an instantaneous bandwidth of 1 GHz, with effective B1 fields ~ 15 G, and very low levels of spurious. This combination of relatively high frequency, high B1, high bandwidth, high filling factor and high

sample volume allows the spectrometer to operate with very high EPR concentration sensitivity, which exceeds that of commercial instruments (at any frequency) for many common measurements. RF excitation also allows high sensitivity ENDOR and DNP measurements.

The spectrometer also features more than 100 dB isolation between sample and source and can have up to 80 dB isolation between source and detector. This means for strong EPR signals (for example associated with DNP polarisers), it is possible to make zero-deadtime EPR measurements where high-quality signals can be measured during a kW pulse with sub-nanosecond time resolution. This allows direct evaluation of the effectiveness of saturation pulses, and measurement of nanosecond relaxation processes.

In this poster we will give a number of examples illustrating new capabilities, often associated with wideband chirped pulses. These include Mn PELDOR featuring 25% modulation depths, pulsed static cross-effect DNP with fast build-up times and enhancements of up to 340 using 4-amino-TEMPO, zero-deadtime measurements and the benefits of using real-time matched filtering in the frequency domain.

EPR POSTER SESSION

Daniel J Sung, University of St Andrews, School of Physics and Astronomy, North Haugh, St Andrews, Scotland, KY169SS, United Kingdom
E-mail: ds222@st-andrews.ac.uk

233 Modulating Berry-Phase Interference Using a Pneumatic-Pressure Based Probe

Kobe Thompson,¹ Brendan Sheehan,^{1,2} Rafael Cassaro,³ Jonathan R Friedman¹

1. Department of Physics and Astronomy, Amherst College, Amherst, Massachusetts 01002, USA
2. Department of Physics, University of Massachusetts Amherst, Amherst, Massachusetts 01003, USA
3. Instituto de Química, Universidade Federal do Rio de Janeiro, Rio de Janeiro, RJ 21941-909, Brazil

The Single Molecule Magnet (SMM) $[\text{Ni}(\text{hmp})(\text{dmb})\text{Cl}]_4$ (Ni_4) has four-fold rotational symmetry about its easy axis. This symmetry affects the spin tunneling dynamics through a Berry-phase-interference effect¹. This symmetry can be broken, and the dynamics modified, via the introduction of perturbations perpendicular to the easy axis of magnetization. One outcome of this broken symmetry is a modulation of the Berry-phase interference with the size of the perturbation². Applying uniaxial pressure perpendicular to the easy axis of the single crystal of Ni_4 , we monitor ESR spectra of the sample as a function of applied pressure to look for evidence of Berry-phase modulation by the pressure. We investigate whether pressure induces a transverse anisotropic term to the system spin Hamiltonian or if the observed changes can be attributed to other changes in the Hamiltonian. Results of this study may help inform our understanding of the interplay between pressure and an applied magnetic field in the spin dynamics of Ni_4 .

[1] Sheehan et al., Phys. Rev. B, **2020**, 22, 102.

[2] Foss-Feig and Friedman, EPL, **2009**, 2, 86.

EPR POSTER SESSION

Kobe I Thompson, 9522 Still Cove Ln, Houston, Texas, 77089, United States
Tel: 8327140627, E-mail: kthompson24@amherst.edu

234 Chemical Mimicry: Designing Magnetic Nuclei to Act Like Electrons

Okten Ungor, Joseph M. Zadrozny

Colorado State University, Department of Chemistry, Fort Collins, CO 80523

Quantum sensing has immense potential to revolutionize the detection of local chemistry by utilizing electron spins that are highly sensitive to their chemical environment. Although quantum sensing has many possible applications, the characterization of internal temperatures within a system (such as the human body) has a myriad of interesting and relevant potential outcomes. By harnessing the temperature-dependent resonance signals emitted by molecular spins, we can achieve high-resolution non-invasive thermometry, a capability of significant value in biomedical imaging. Towards this application, our research focuses on exploring the interaction between electron spins and metal complexes containing ^{59}Co nuclear spins. These complexes exhibit exceptional sensitivity in the ^{59}Co chemical shift (δ) and relaxation times (T_1 and T_2) in response to changes in local electron density. Such sensitivity arises from the contributions of $d-d$ excited states to δ and the quadrupolar $I = 7/2$ ^{59}Co nucleus to T_1 and T_2 . We propose a route to achieving even higher temperature sensitivity through coupling spin crossover, an electron-spin phenomenon, to ^{59}Co NMR. For the proof of concept, we studied the complexes $[(\text{CpCo}(\text{OP}(\text{OR})_2)_3)_2\text{Co}](\text{SbCl}_6)$ [$\text{R} = \text{Me}$ (1), Et (2), $i\text{-Pr}$ (3), and $t\text{-Bu}$ (4)]. All complexes undergo a different degree of spin transition between $S = 0$ to $S = 2$ spin-crossover at the cobalt center. Variable-temperature ^{59}Co nuclear magnetic resonance spectra at ca. 118.67 MHz revealed record-breaking chemical-shift temperature sensitivities for any nuclear spin. Furthermore, we demonstrate that the degree of mimicry can be tuned by selecting specific R groups in the presented complexes, leading to varying temperature sensitivities. This work opens up new avenues for quantum mimicry designing magnetic nuclei with tailored properties, expanding the possibilities for enhanced quantum sensing applications in diverse areas of research and technology.

EPR POSTER SESSION

Okten Ungor, 3605 Precision Drive, Fort Collins, Colorado, 80528, United States

E-mail: oungor@colostate.edu

235 **The Role of a Conserved Ionic Lock in Transport by an Outer Membrane Protein**

Viranga W Wimalasiri,¹ David S. Cafiso

1. Department of Chemistry

2. Center for Membrane and Cell Physiology, University of Virginia

Gram-negative bacteria such as *Escherichia coli* (*E. coli*) take up nutrients such as vitamin B12, iron, and carbohydrates through a family of outer-membrane TonB-dependent transporters (TBDTs). These TBDTs are essential for the success of many pathogens as well as for the proper function of the human microbiome, and they obtain energy from the inner-membrane (IM) proton motive force by coupling to the IM protein TonB. Although numerous high-resolution structures of different TBDTs have been determined, the molecular mechanism of transport remains uncharacterized. The *E. coli* Vitamin B12 transporter BtuB is highly allosteric. EPR spectroscopy has shown that the binding of substrate to the extracellular surface shifts the equilibrium of an energy coupling segment termed the Ton box towards an extended or disordered state. This may make the Ton box available for coupling with the IM protein TonB. Disrupting a conserved ionic lock (D316/R14) between the protein beta-barrel and the core of the protein eliminates this substrate-dependent coupling and shifts the Ton box equilibrium towards an unfolded state. In the present work, we have used pulse EPR spectroscopy to compare the conformational state of the Ton box induced by substrate with that produced by mutation of the conserved ionic lock. These measurements were carried out both in native and reconstituted systems, since allostery in this protein is known to be modulated by the native membrane environment. The data show that mutating the ionic lock produces a more extended state of the Ton box than does substrate, and that this state can be mimicked by the binding of a C-terminal fragment of TonB, suggesting a mechanism of transport.

EPR POSTER SESSION

Viranga W Wimalasiri, University of Virginia, 409 McCormick Road, Charlottesville, Virginia, 22904, United States

Tel: 4342426991, E-mail: vww4u@virginia.edu

INDEX OF PRESENTERS

Name	Abstract No.	Name	Abstract No.	Name	Abstract No.
Abdo Arias, Francisca	200	Pagel, Marty	150		
Acosta, Victor	123	Pierce, Brad	101		
Agrachev, Mikhail	131	Price, Brad	146		
Allridge, Elijah	201	Qin, Peter	113		
Amassah, Georgina	202	Ren, Yuhang	122		
Atwood, Sabastian	109	Ruthstein, Sharon	100		
Blank, Aharon	120	Sahoo, Gyana Ranjan	142		
Bogetti, Xiaowei	105, 203	Schmidt, Thomas	114		
Brennan, Patrick	204	Sheehan, Brendan	129, 227		
Burgett, Russell	205	Sinha Roy, Aritro	147		
Cafiso, David	111	Smirnov, Alex	143		
Canny, Autumn	206	Smirnova, Tatyana	107, 228		
Carmielli, Raanan	132	Sojka, Antonin	144		
Casto, Josh	106, 207	Solodovnyk, Artur	136		
Chen, Guanchu	133	Srivastava, Madhur	103		
Elajaili, Hanan	115	Srivastava, Nimesh	153		
Epel, Boris	151	Stoll, Stefan	148, 229		
Fanucci, Gail	112	Stowell, Rachelle	230		
Fittipaldi, Maria	130	Subramanya, Manoj	128		
Flores, Marco	208	Sung, Daniel	231, 232		
Franck, John	137, 209	Thompson, Kobe	233		
Garces, Alexander	210	Tsay, Karen	149		
Greer, Samuel	211	Ungor, Okten	234		
Grosskopf, Julian	212	Weiss, Leah	127		
Grüne, Jeannine	125, 213	Wimalasiri, Viranga	235		
Halpern, Howard	108	Woodcock, Lukas	145		
Hasanbasri, Zikri	116, 214	Yang, Hao	102		
Hovey, Tanden	215				
Kaminker, Ilia	119				
Kay, Chris	121				
Keller, Timothy	216				
Kincaid, Warren	217				
Kisgeropoulos, Effie	218				
Kotecha, Mrignayani	152, 219				
Liu, Junjie	110				
Lockhart, Molly	220				
MacRae, Austin	221				
Maity, Shiny	117				
Mandato, Alysia	138, 222				
Marohn, John	139, 223				
Martinez, Roxanna	224				
McHenry, Trent	126				
McKay, Colin	140				
Milhauser, Glenn	104				
Misra, Sushil	118				
Neugebauer, Petr	141, 225				
Niklas, Jens	226				
Ozarowski, Andrew	135				

CRYOGEN-FREE MAGNETS FOR SOLID STATE NMR

600 MHz cryogen-free NMR magnet system



Operating fields to 14.1 T / 600 MHz

- ≤ 1 ppm fixed field central homogeneity
- Multifield option without compromising on resolution
- ~ 50 ppm variable field central homogeneity
- Rapid << 0.1 ppm / hr drift in persistent mode
- Fast field settling (within an hour)
- Superconducting sweep coils
- Custom configuration available for DNP
- Designed to minimise vibration resulting in low sample displacement

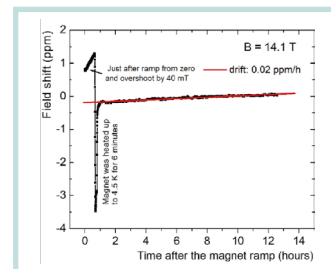

Sample environment

- Temperature range between 1.3 K to 400 K
- Top or bottom load probe
- Room temperature bore / variable temperature Insert

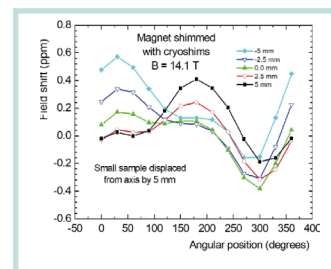

CRYOGEN-FREE CRYOSTAT FOR ESR / EPR

COMPACT DESKTOP SPLIT PAIR MAGNET SYSTEM FOR EPR EXPERIMENTS

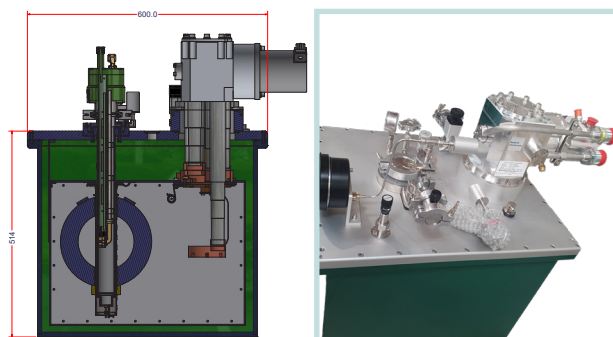
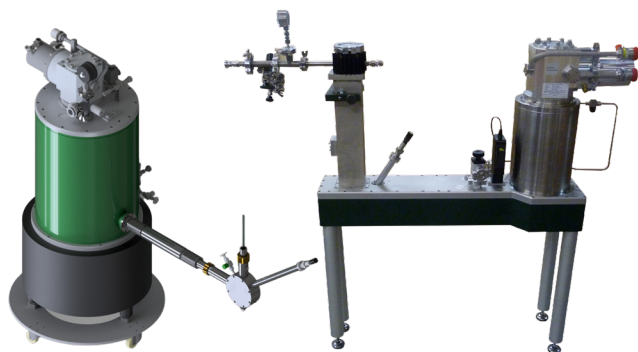

- No liquid cryogens
- Closed cycle operation
- Low vibration signature
- Fast initial cooldown of approximately 4 hours
- Rapid sample easy change
- Sample temperature range from less than 4 K to 300 K

- Cryogen-free 3.4 T superconducting split pair magnet with horizontal field
- Central field homogeneity 25 ppm over 10 mm DSV
- 0.1 ppm / hr decay rate persistent switch
- Ø 40 mm vertical integrated variable temperature insert
- Temperature control between 2 K – 325 K



Cryogenic UK
Tel: +44 20 8743 6049 Email:
sales@cryogenic.co.uk

Cryogenic US
Tel: +1 919 717 5163
Email: sales@cryogenic-usa.com

CRYOGENIC

www.cryogenic.co.uk